



DRAWINGS

Rampes mobiles
Rampes fixes
Plateformes logistiques
Réhaussees
Tables de quai mobiles
Tables de quai fixes
Passerelles
Rampes pour conteneurs
Niveleurs
Autres confections



DRAWINGS

Rampes mobiles

Rampes fixes

Plateformes logistiques

Réhausse

Tables de quai mobiles

Tables de quai fixes

Passerelles

Rampes pour conteneurs

Niveleurs

Autres confections

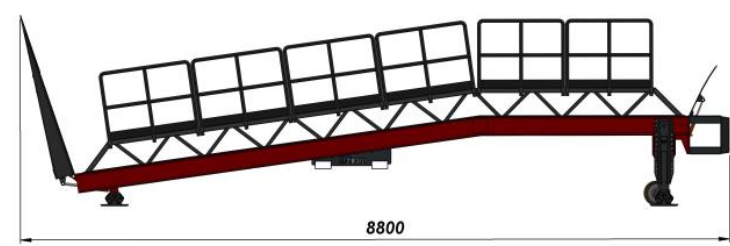
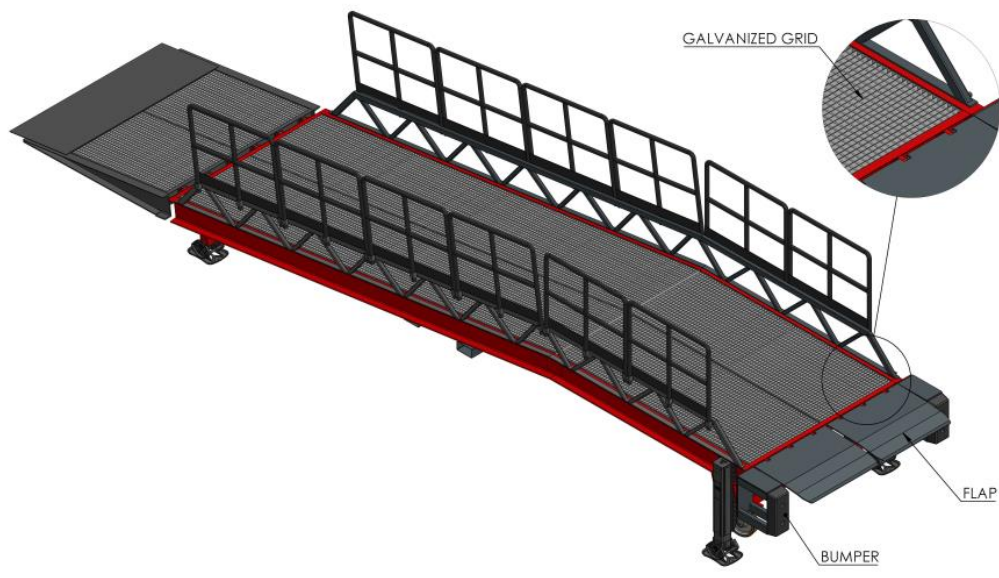
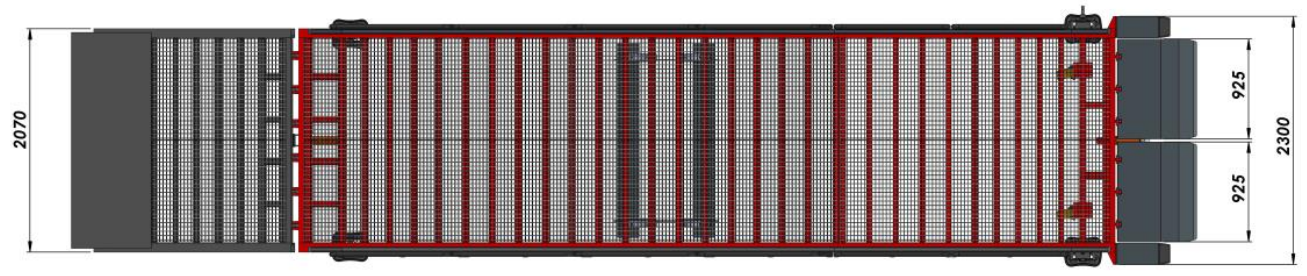
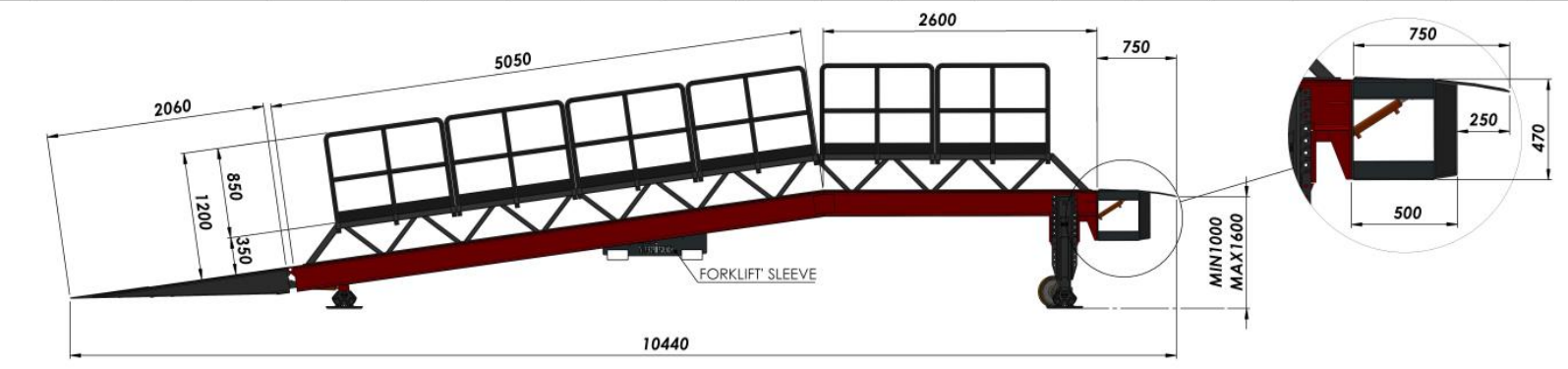

NAME - SURNAME	DATE	SIGN	QUANTITY	MASS (KG)	MATERIAL	PAGE/HR
DRAWN BY: H. CANSEVER	11.01.2022		---			1/1
CONTROL: A. HEPBILDI	11.01.2022					
APPROVAL: S. ENTZMANN	11.01.2022					
SCALE: 1:50						
PART/ASSEMBLY NAME	DRAWING DESCRIPTION:		DRAWING NO.			
	STAR STANDART (8-10-12 TONS)+ 120 CM GUARDRAIL + REFUGE ZONE + FORKLIFT S SLEEVE		---			3

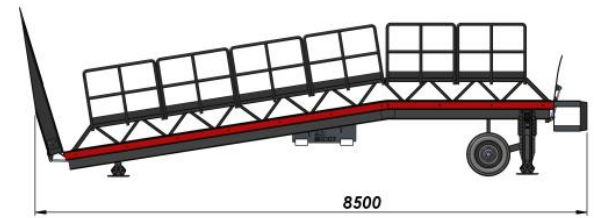
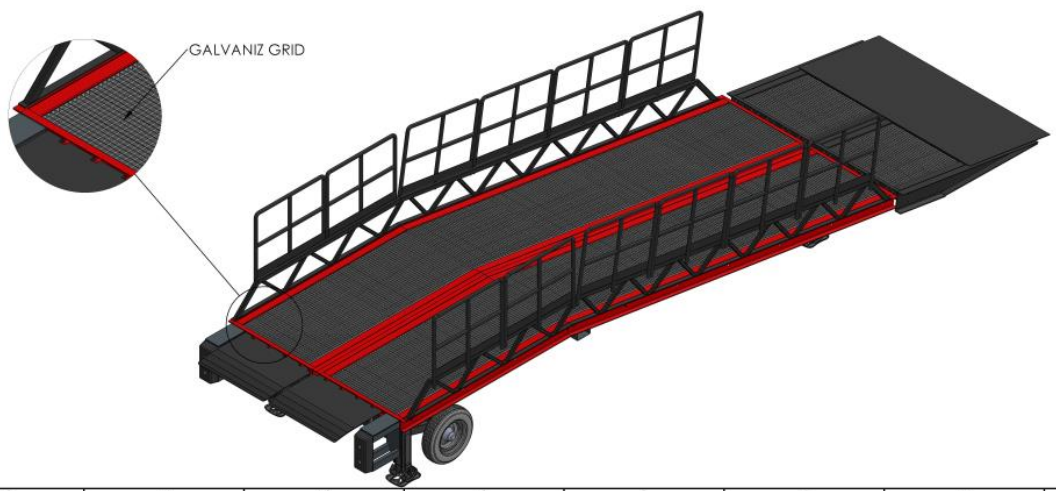
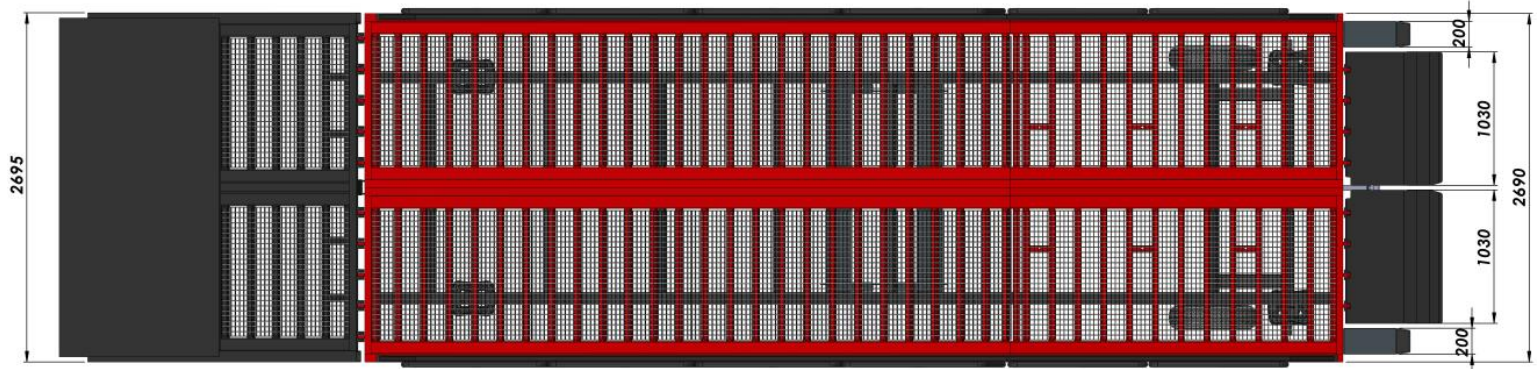
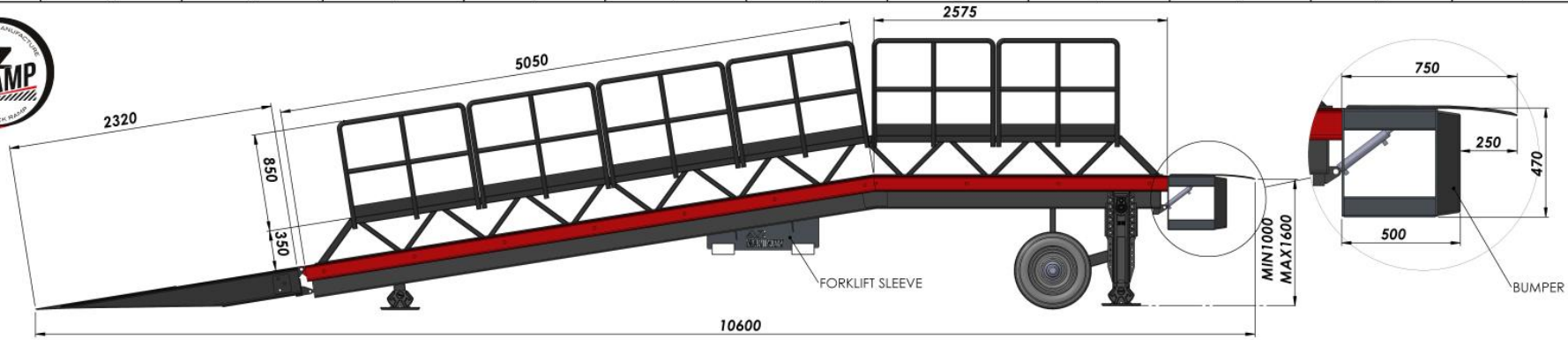

NAME - SURNAME	DATE	SIGN	QUANTITY	MASS (KG)	MATERIAL	PAGE NR
DRAWN BY: H. CANSEVER	04.02.2022		---			1/1
CONTROL: A. HEPBILDI	04.02.2022					
APPROVAL: S. ENTZMANN	04.02.2022					
SCALE: 1:100						
PARTS/ASSEMBLY NAME	DRAWING DESCRIPTION:		DRAWING NO.			
	STAR-KING-S (8-10-12 TONS)		---			

AZ MACHINERY - SLU, Matériels d'Élévation et Manutention
 13 rue de la scierie - 66340 PALAISEY DE CERDAGNE - France
 Téléphone : +33 37 37 46 100 - contact@az-machinery.com - www.az-machinery.com
 Site : S24 654 958 000 19 - TVA : FR02 824 654 958 - N° EORI : FR02 824 654 958

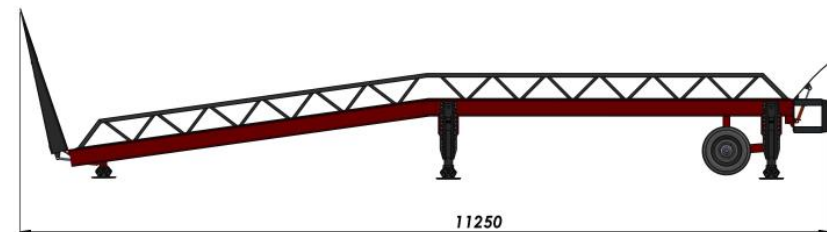
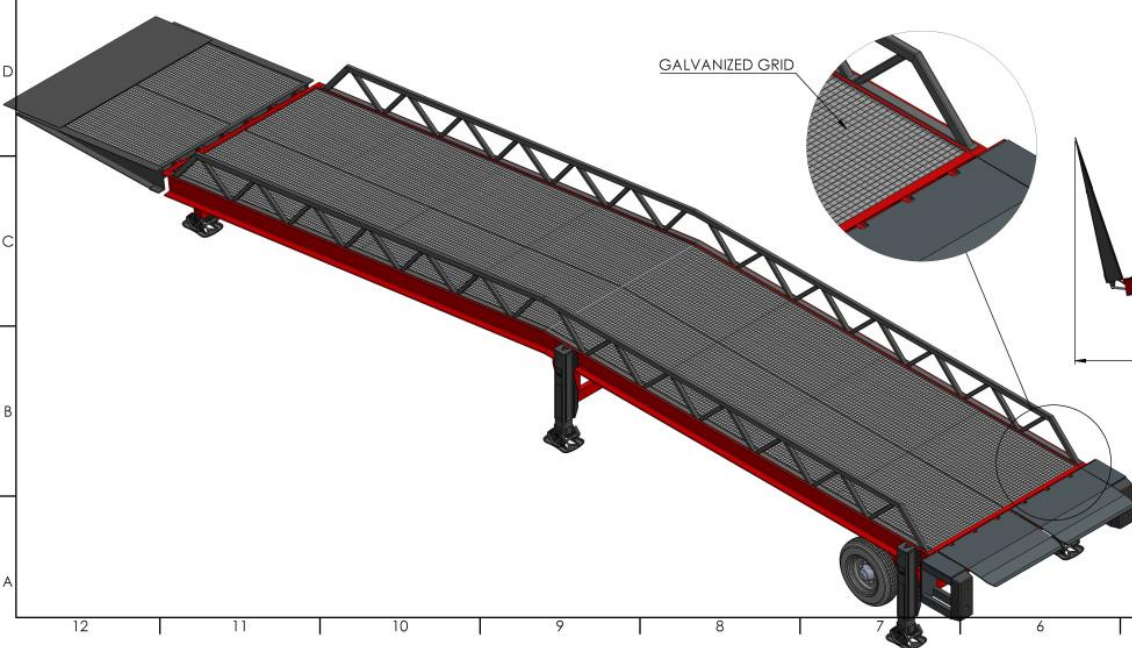
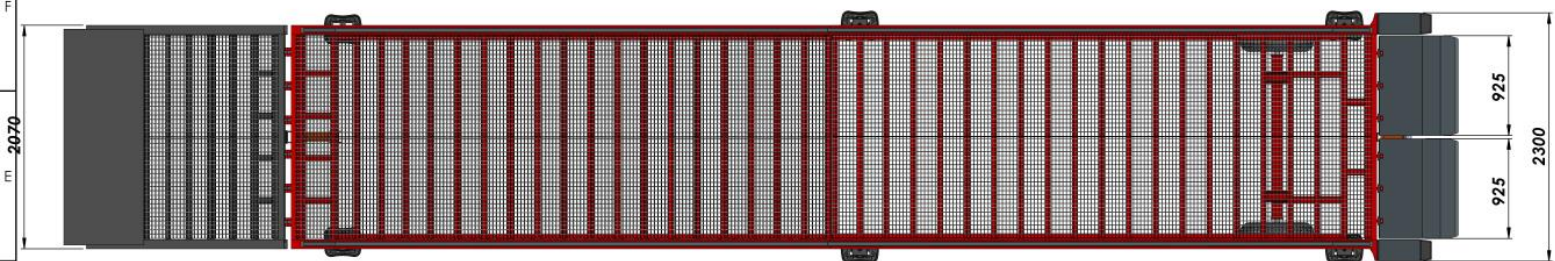
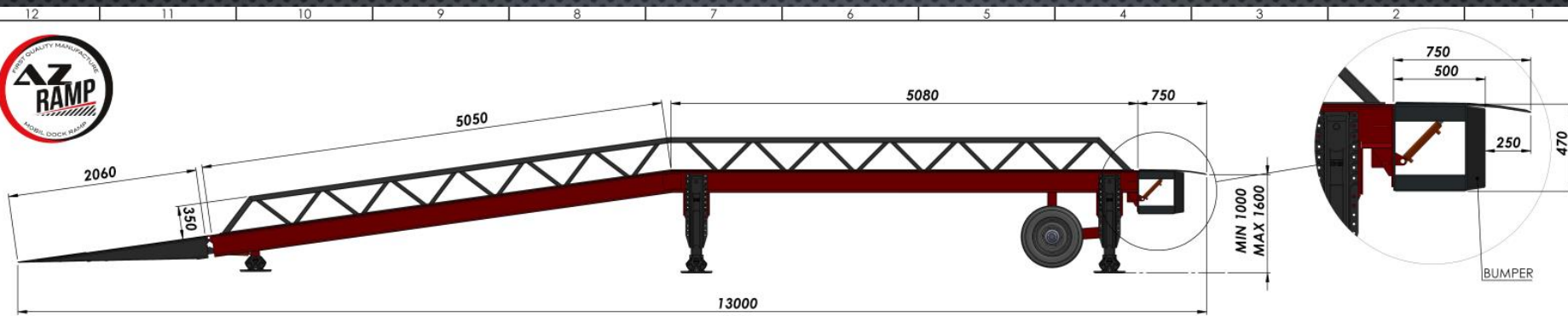

NAME-SURNAME	DATE	SIGN	QUANTITY	MASS (KG)	MATERIAL	PAGE/NI
DRAWN BY: H. CANSEVER	11.01.2022		---			1/1
CONTROL: A. HEPBILDI	11.01.2022					
APPROVAL: S. ENTZMANN	11.01.2022					
SCALE: 1:50						
PART/ASSEMBLY NAME	DRAWING DESCRIPTION:		DRAWING NO.			
	STAR LLO (8-10-12-15-20 TONS)		---			5

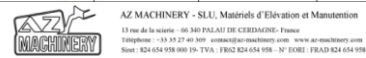

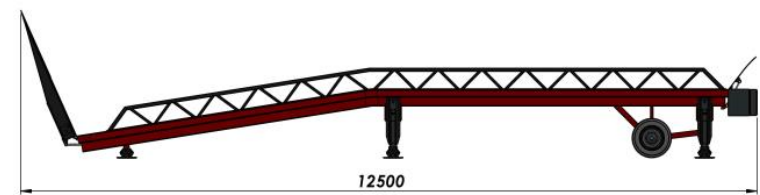
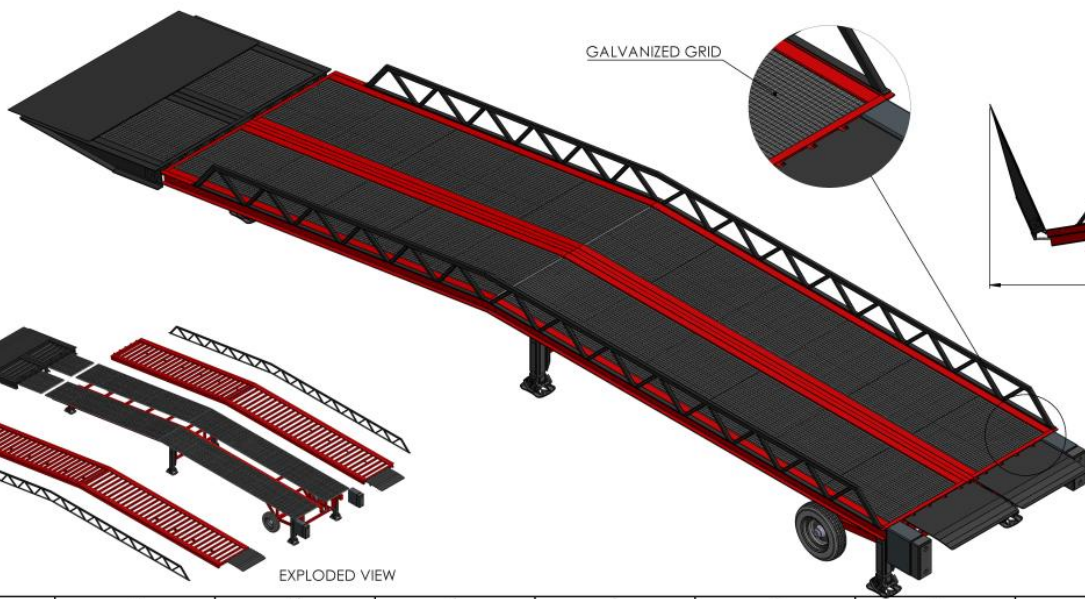
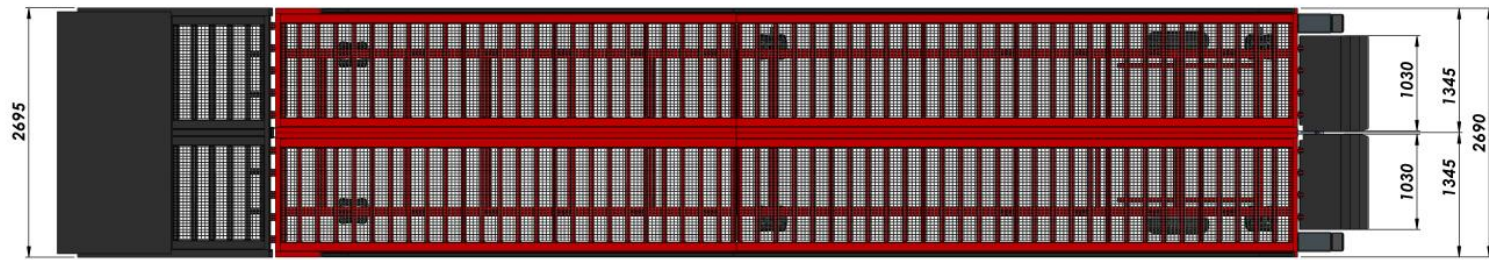
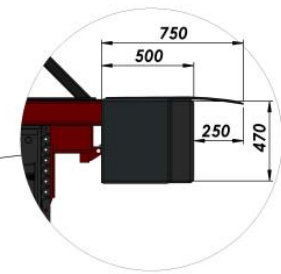
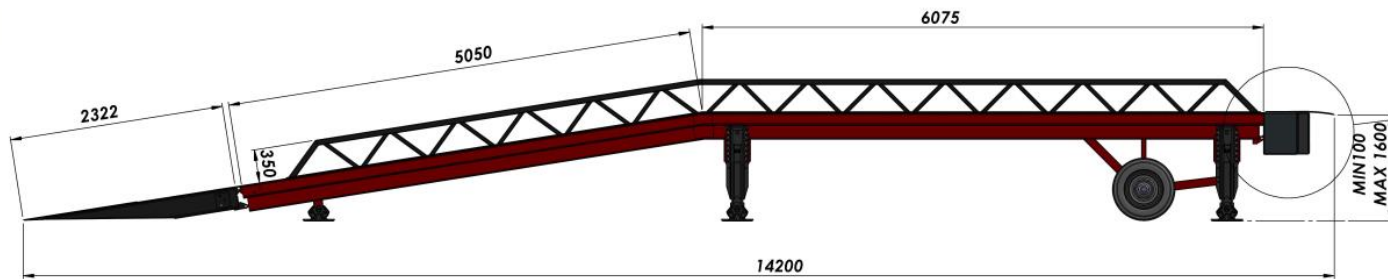

NAME - SURNAME	DATE	SIGN	QUANTITY	MASS (KG)	MATERIAL	PAGE (NR)
DRAWN BY: H. CANSEVER	11.01.2022		---			1/1
CONTROL: A. HEPBILDI	11.01.2022					
APPROVAL: S. ENTZMANN	11.01.2022					
SCALE: 1:100						
PART/ASSEMBLY NAME	DRAWING DESCRIPTION:		DRAWING NO.			
	STAR-XL (8-10-12-15-20 TONS)		---			6

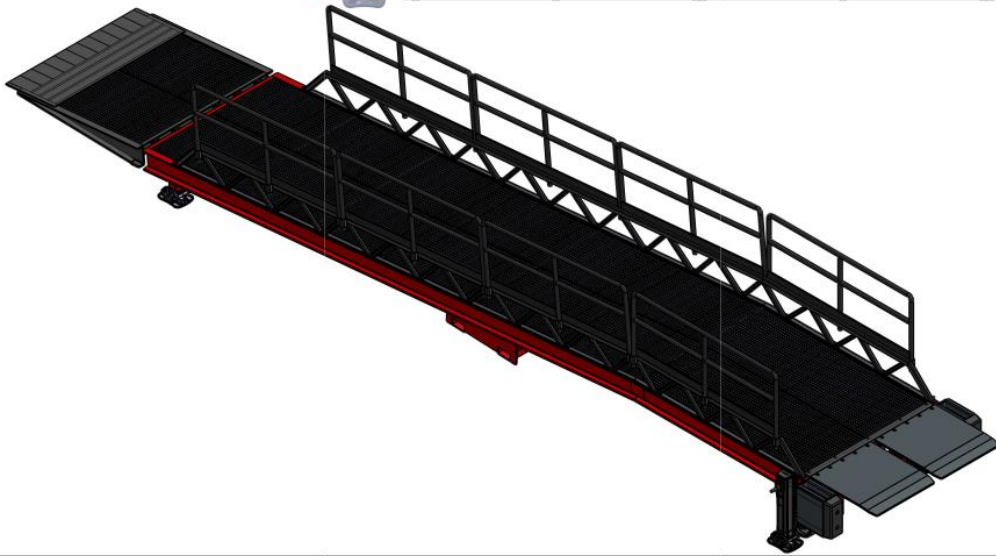
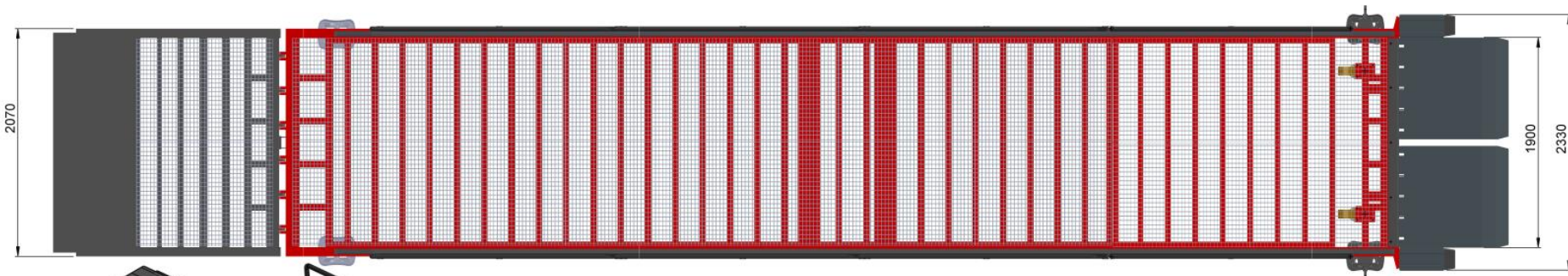
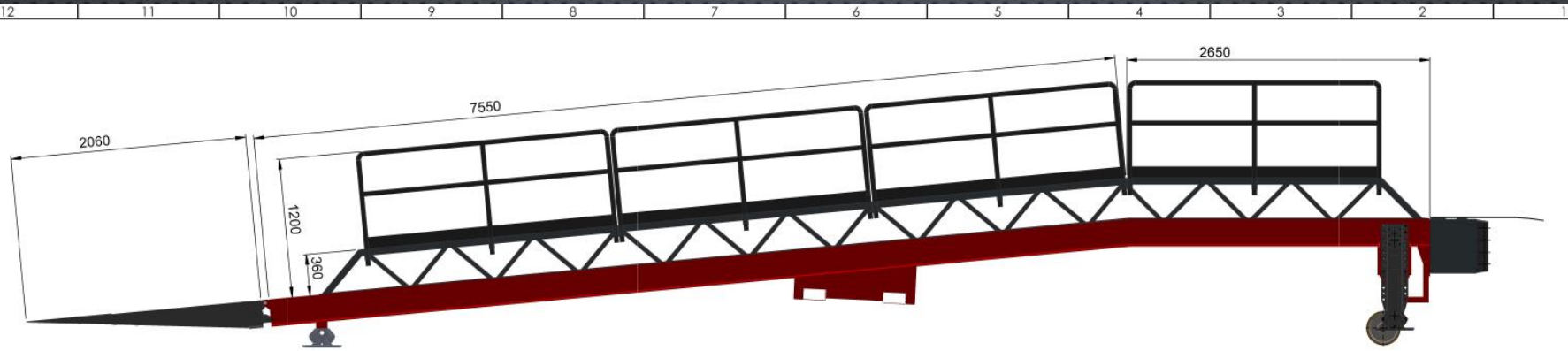

NAME - SURNAME	DATE	SIGN	QUANTITY	MASS (KG)	MATERIAL	PAGE (NR)
---	---	---	---	---	---	1/1
CONTROL	---	---	---	---	---	---
APPROVAL	---	---	---	---	---	---
SCALE	1:50	---	---	---	---	---
PART/ASSEMBLY NAME			DRAWING DESCRIPTION		DRAWING NO.	
			#79US ---		---	



AZ MACHINERY - SLU, Matériels d'Élévation et Maintenance
 13 rue de la société - 05 340 PÉLASSI DE CERDANNE - France
 Téléphone : +33 37 27 46 100 - contact@az-machinery.com - www.az-machinery.com
 Site : 024 654 958 000 10 - TVA : FR02 824 654 958 - N° EORI : FR02 824 654 958

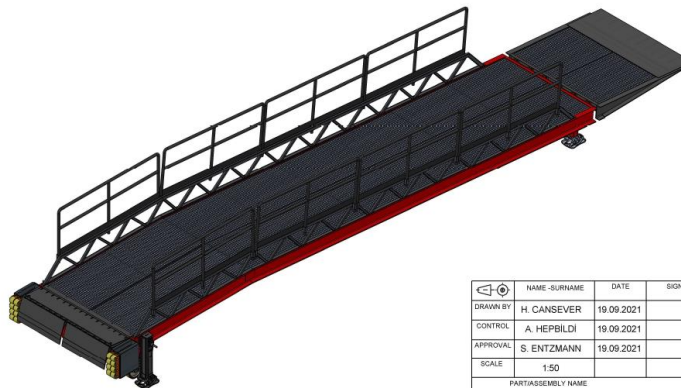
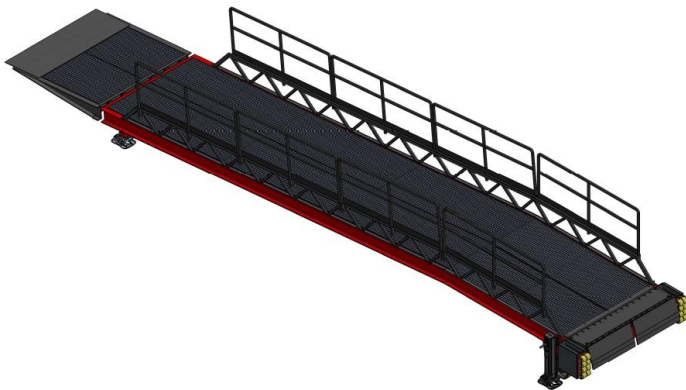
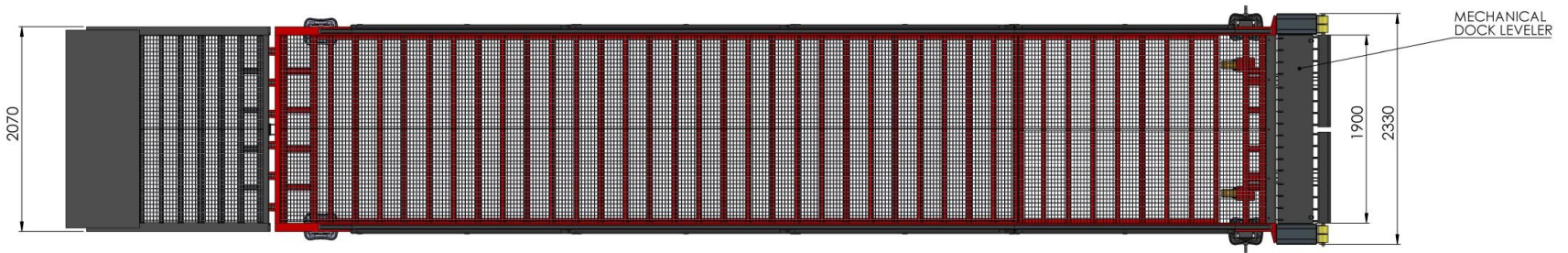
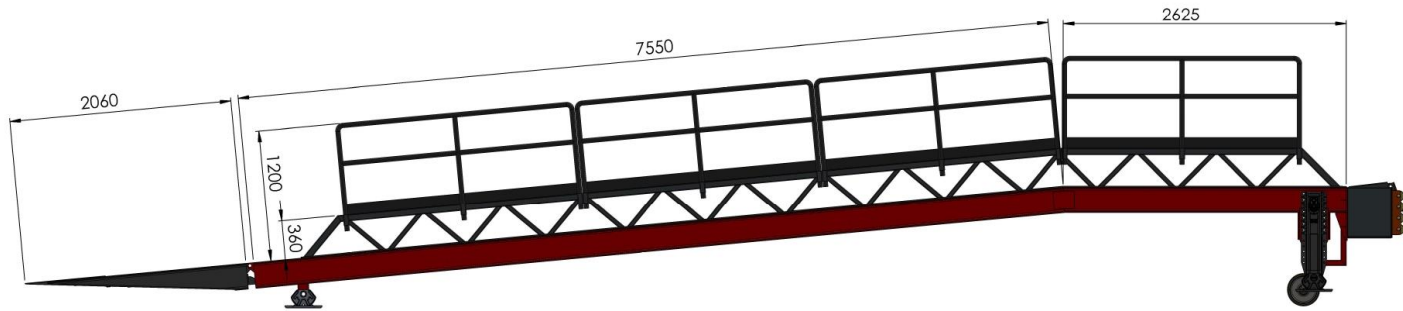

NAME-SURNAME	DATE	SIGN	QUANTITY	MASS (KG)	MATERIAL	PAGE NR
DRAWN BY H. CANSEVER	19.09.2021		---			1/1
CONTROL A. HEPBILDI	19.09.2021					
APPROVAL S. ENTZMANN	19.09.2021					
SCALE 1:50						
PARTASSEMBLY NAME			DRAWING DESCRIPTION			DRAWING NO
			EASY-STAR-OTC			---



AZ MACHINERY - SLU, Matériels d'Élévation et Maintenance
 13 rue de la scierie - 06 540 PALAISEAU DE CERBERACRE - France
 Téléphone : +33 (0) 47 46 1001 - contact@az-machinery.com - www.az-machinery.com
 Site : 024 654 958 000 19 - TVA : FR02 824 654 958 - N° EORI : FR02 824 654 958

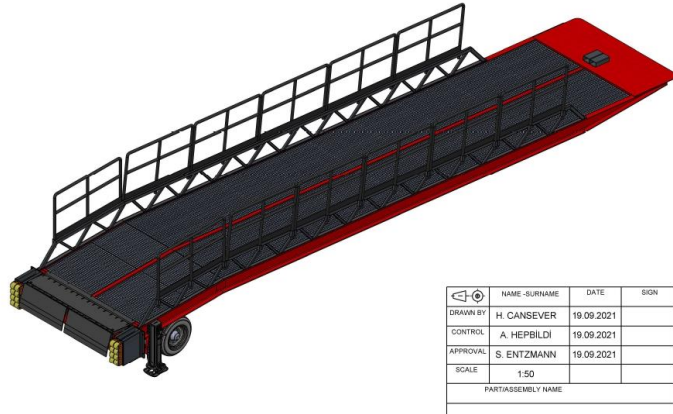
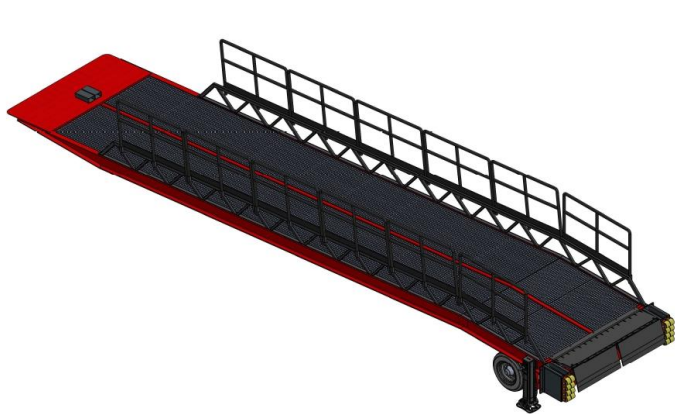
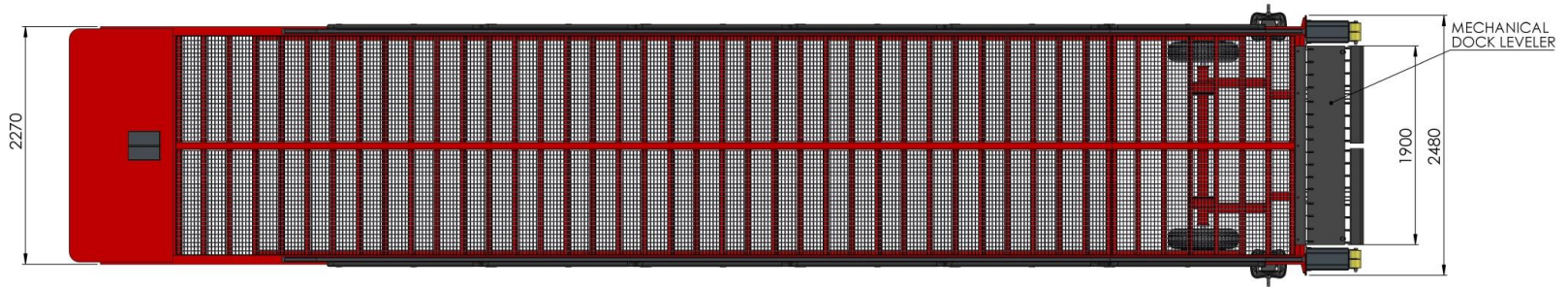
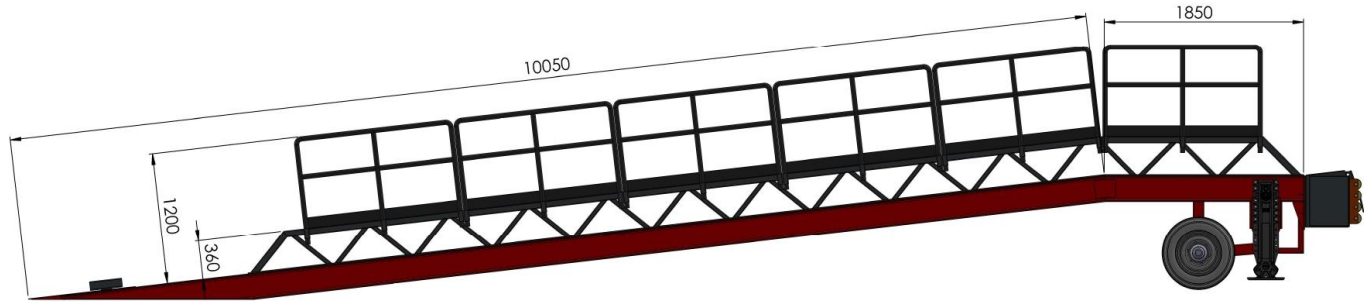

NAME-SURNAME	DATE	SIGN	QUANTITY	MASS (KG)	MATERIAL	PAGE NR
DRAWN BY: H. CANSEVER	19.09.2021		---			1/1
CONTROL: A. HEPBILDI	19.09.2021					
APPROVAL: S. ENTZMANN	19.09.2021					
SCALE: 1:50						
PARTASSEMBLY NAME	DRAWING DESCRIPTION		DRAWING NO			
	EASY-T-XL-OTC		---			



AZ MACHINERY - SLU, Matériels d'Élévation et Manutention
 13 rue de la scierie - 06 340 PALAIS DE CERDAGNE - France
 Téléphone : +33 (0) 47 48 500 - contact@az-machinery.com - www.az-machinery.com
 Site : 824 654 958 000 FR - TVA : FR02 824 654 958 - N° EORI : FRAD 824 654 958

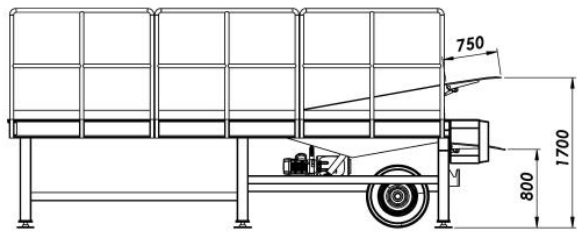
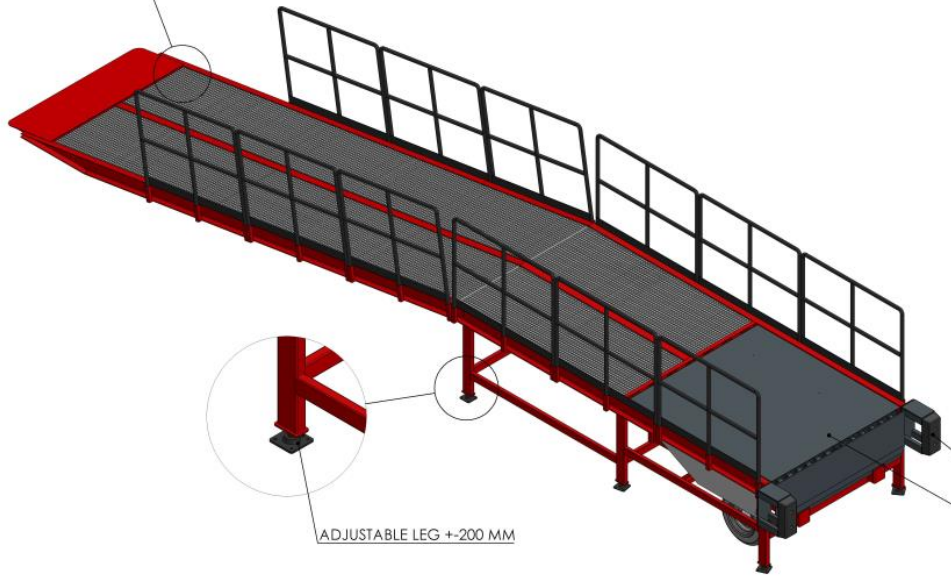
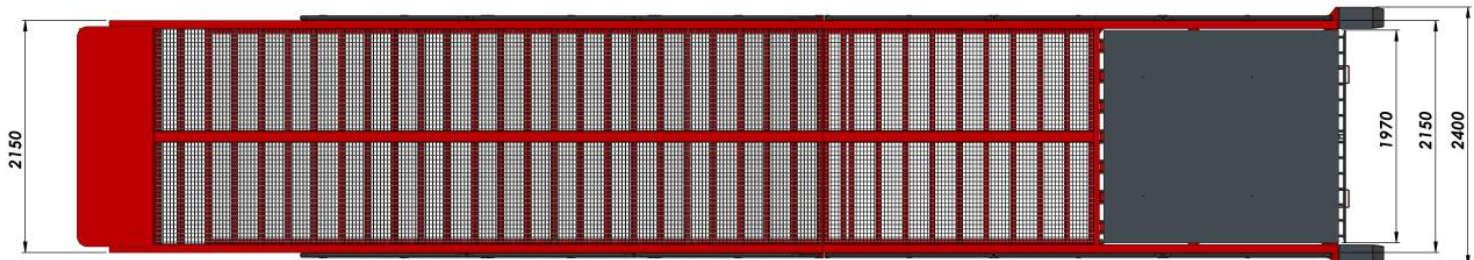
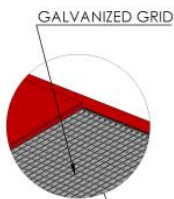
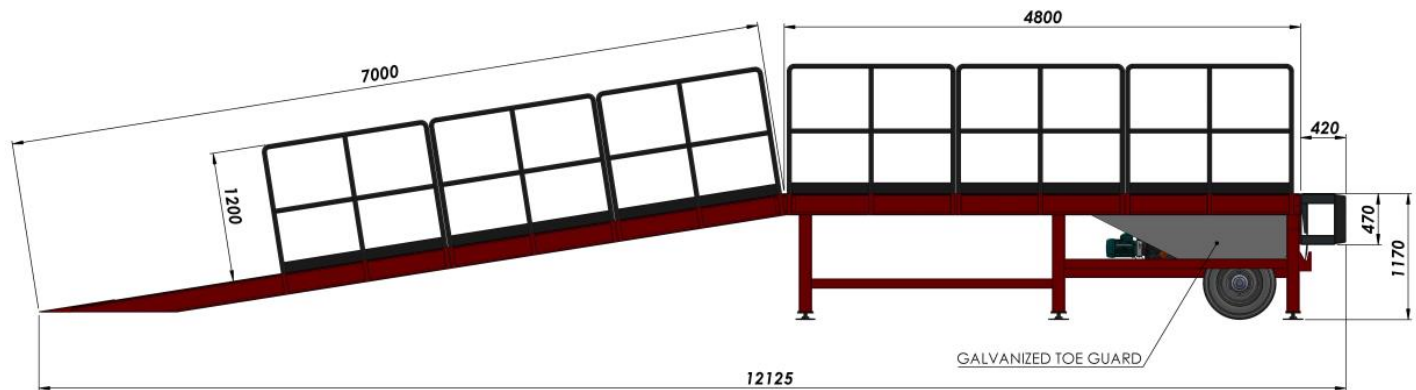

NAME - SURNAME	DATE	SIGN	QUANTITY	MASS (KG)	MATERIAL	PAGE NR
DRAWN BY: H. CANSEVER	11.01.2022		---			1/1
CONTROL: A. HEPBILDI	11.01.2022					
APPROVAL: S. ENTZMANN	11.01.2022					
SCALE: 1:50						
PARTS/ASSEMBLY NAME			DRAWING DESCRIPTION:		DRAWING NO.	
			FORMATION 2020 MOBILE		---	



AZ MACHINERY - SLU, Matériels d'Élévation et Manutention
 13 rue de la scierie - 05 340 PÉLASSI DE CERDANNE - France
 Téléphone : +33 37 27 46 300 - contact@az-machinery.com - www.az-machinery.com
 Site : 024 654 958 000 TVA - TVA : FR02 824 654 958 - N° EORI : FRAD 824 654 958

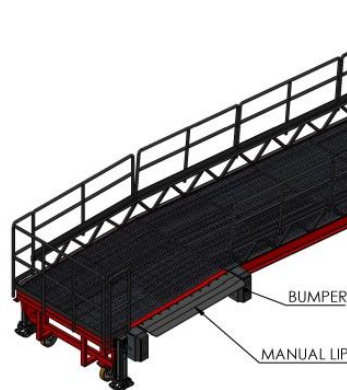
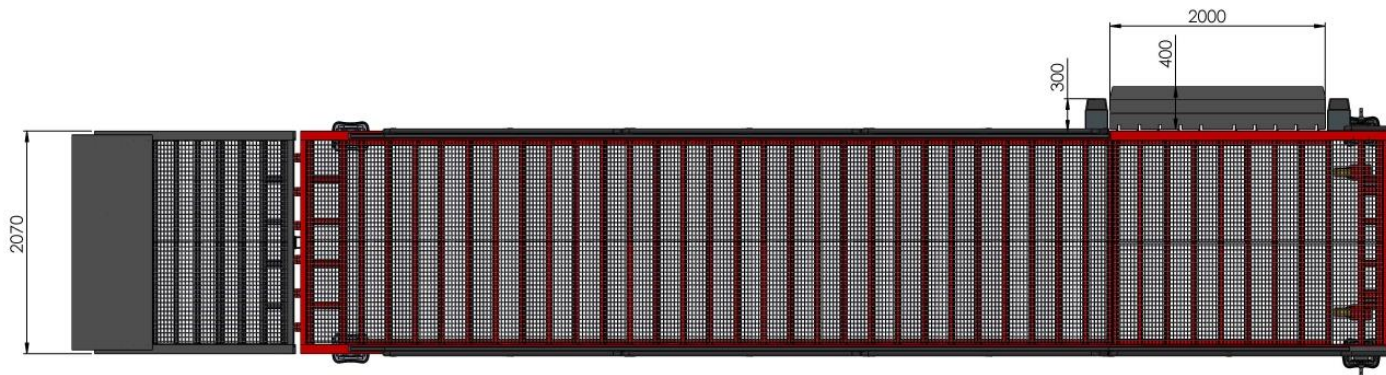
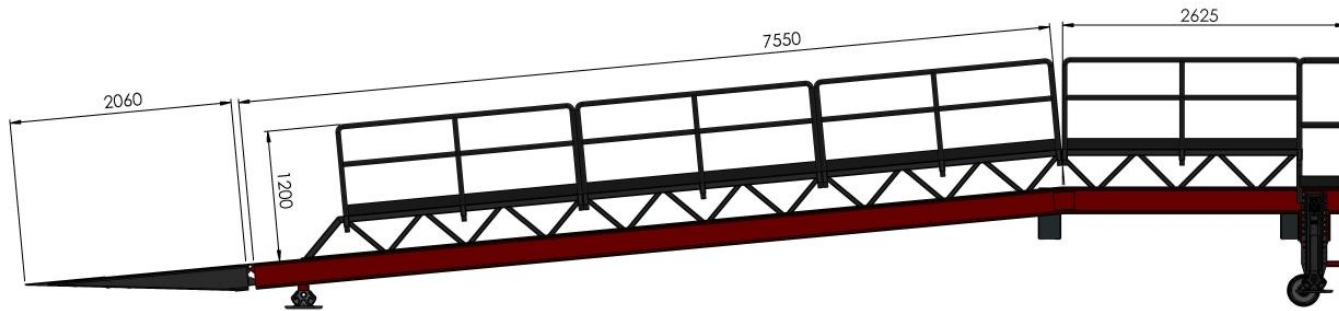

NAME-SURNAME	DATE	IGN	QUANTITY	MASS (KG)	MATERIAL	PAGE NR
DRAWN BY: H. CANSEVER	---	---	---	---	---	1/1
CONTROL: A. HEPBILDI	---	---	---	---	---	---
APPROVAL: S. ENTZMANN	---	---	---	---	---	---
SCALE: 1:50	---	---	---	---	---	---
PARTS/ASSEMBLY NAME			DRAWING DESCRIPTION			DRAWING NO.
			AZ RAMP special FRA-ORD-63			#27ZE



AZ MACHINERY - S.L.U. Matériels d'Élévation et Manutention
 13 rue de la source - 06340 PALLAS DE CÉREDAON - France
 Téléphone : +33 (0) 49 34 46 500 - contact@azmachinery.com - www.azmachinery.com
 Siret : 824 054 498 00013 - TVA : FR24 824 054 498 - N° RCS : FR24 824 054 498

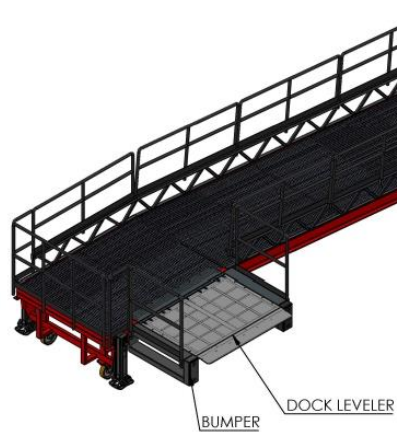
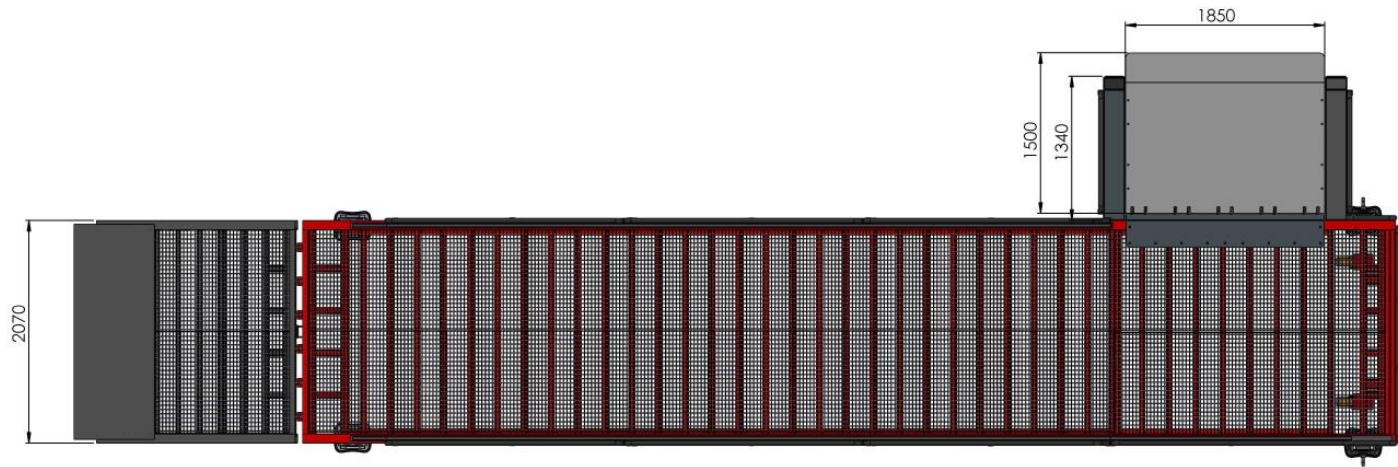
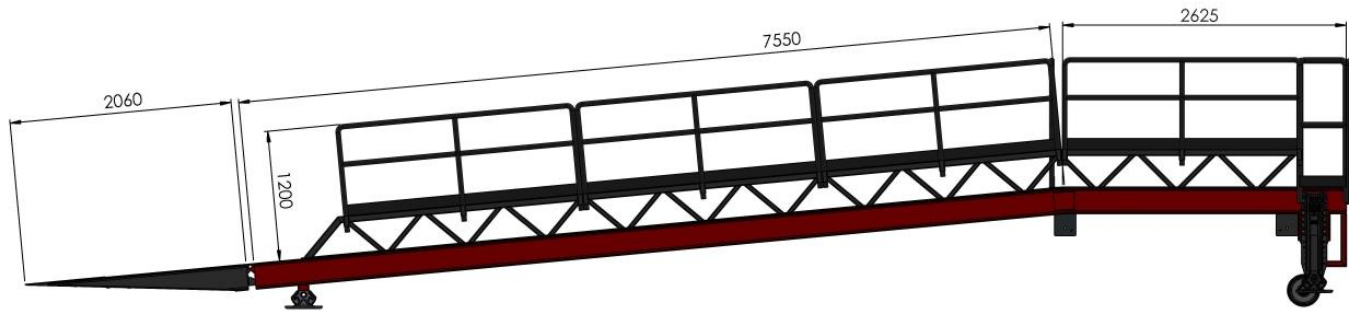

NAME	SURNAME	DATE	IGN	QUANTITY	MASS (KG)	MATERIAL	PAGE NR
DRAWN BY	H. CANSEVER	---	---	---	---	---	1/1
CONTROL	A. HEPBILDI	---	---	---	---	---	---
APPROVAL	S. ENTZMANN	---	---	---	---	---	---
SCALE	1:50	---	---	---	---	---	---
PART/ASSEMBLY NAME				DRAWING DESCRIPTION			DRAWING NO.
				AZ RAMP special			---
				FRA-ORD-63			---



AZ MACHINERY - S.L.U. Matériels d'Élévation et Manutention
 13 rue de la machine - 69 340 PALLAS DE CEREDAINE - France
 Téléphone : +33 (0) 47 42 50 00 - contact@azmachinery.com - www.azmachinery.com
 Siret : 824 054 898 000 10 - TVA : FR20 824 054 898 - N° BIC : FRA20 824 054 898

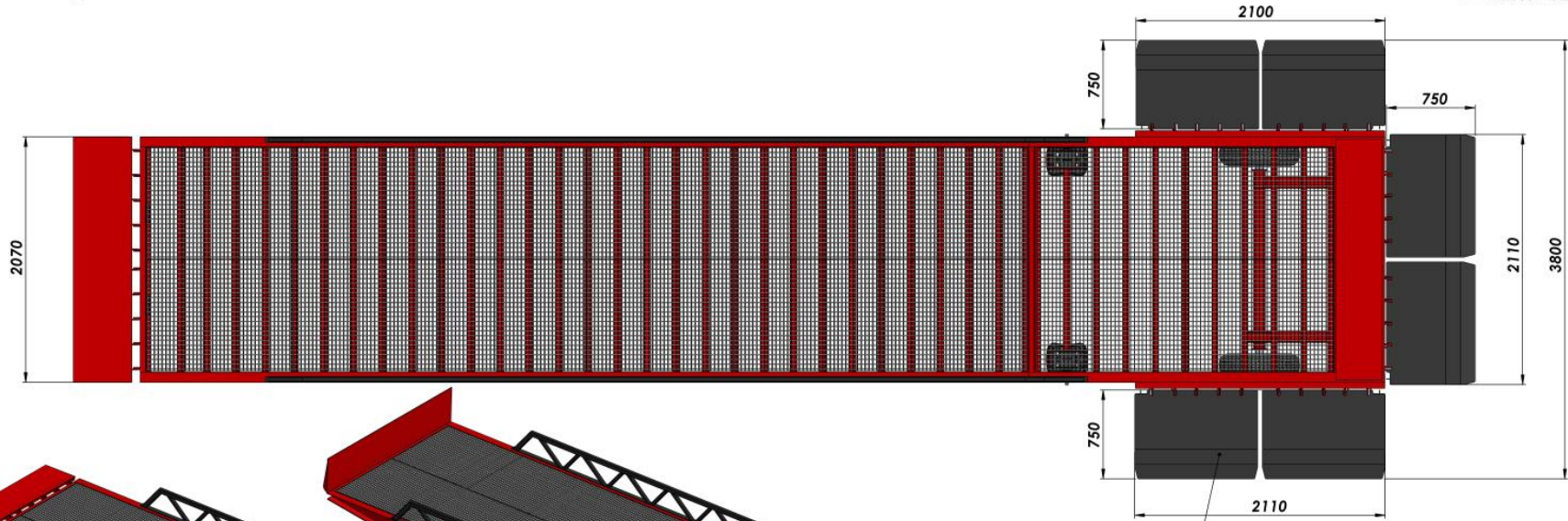
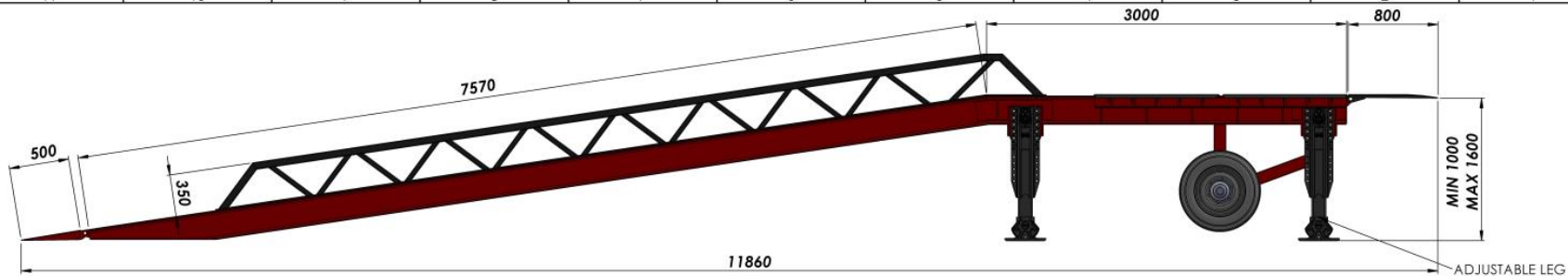

EACH FLAP'S WEIGHT IS 30 KG
 FLAPS WILL HAVE CHAINS FOR LIFT UP
 FLAP COULD LIFT UP EASILY BY HAND

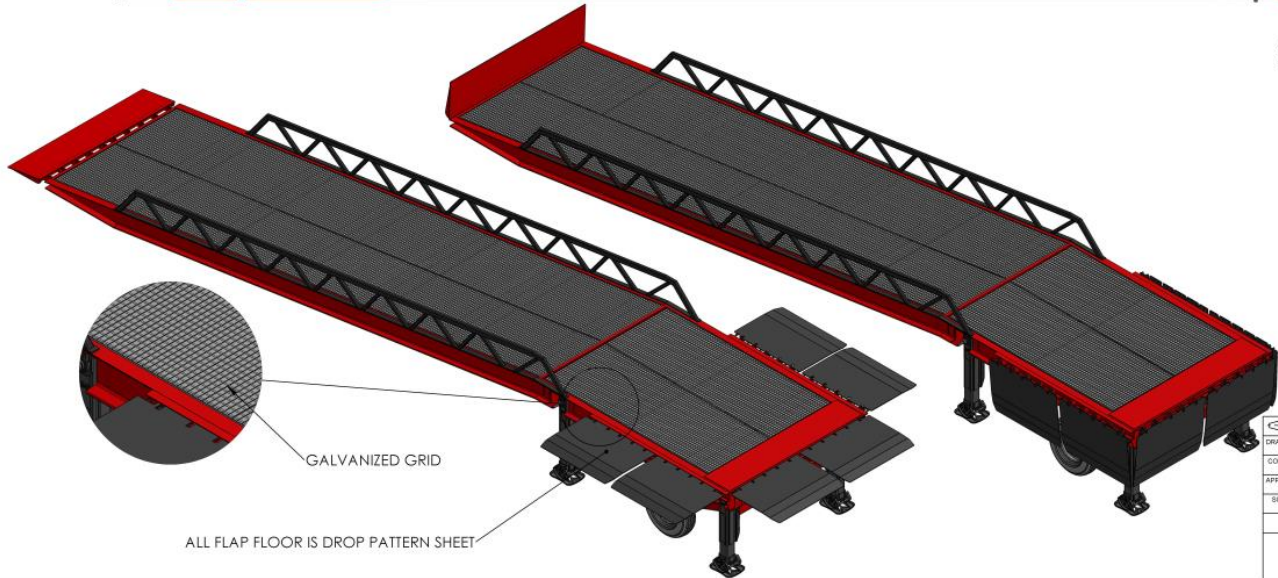

NAME - SURNAME	DATE	SIGN	QUANTITY	MASS (KG)	MATERIAL	PAGE NR
DRAWN BY H. CANSEVER	30.03.2022		---			1/1
CONTROL A. HEPBILDI	30.03.2022					
APPROVAL S. ENTZMANN	30.03.2022					
SCALE	1:50					
PART/ASSEMBLY NAME			DRAWING DESCRIPTION		DRAWING NO.	
			#46TT		---	



AZ MACHINERY - SLU, Matériels d'Élévation et Maintenance
 13 rue de la machine - 46 540 PALLATI DE CÉBERACQRE - France
 Téléphone : +33 (0) 37 48 500 - contact@az-machinery.com - www.az-machinery.com
 Site : 824 654 958 000 FR - TVA : FR02 824 654 958 - 3^e EORL - FR02 824 654 958

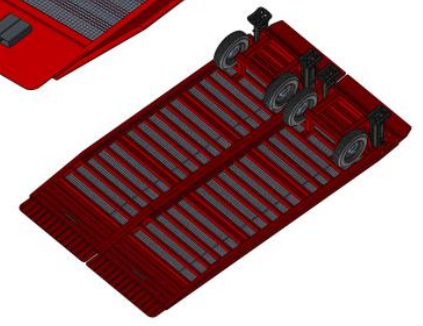
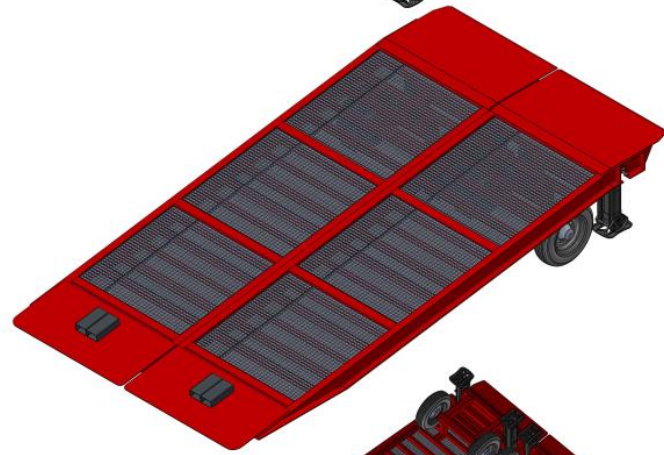
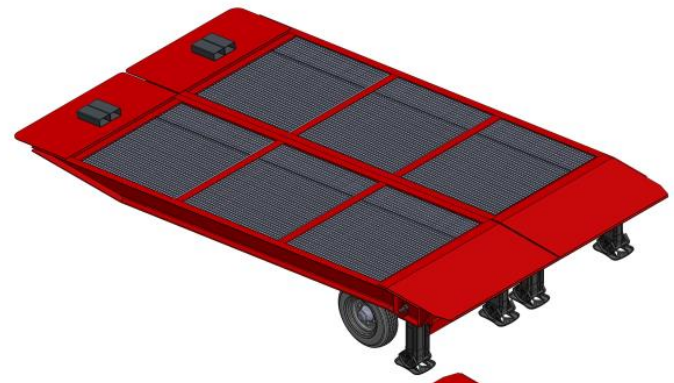
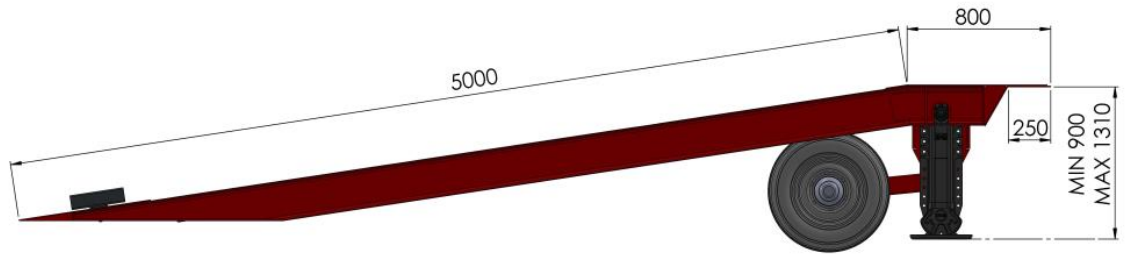

NAME - SURNAME	DATE	SIGN	QUANTITY	MASS (KG)	MATERIAL	PAGE NR
DRAWN BY: H. CANSEVER	27.09.2021		---			1/1
CONTROL: A. HEPBILDI	27.09.2021					
APPROVAL: S. ENTZMANN	27.09.2021					
SCALE: 1:50						
PARTS/ASSEMBLY NAME			DRAWING DESCRIPTION		DRAWING NO.	
			AZ RAMP BIG FOOT CUSTOMISED PYR_KBF		--- #SUSP	



AZ MACHINERY - SLU, Matériels d'Élévation et Manutention
 13 rue de la scierie - 66 340 PALLATI DE CERDACHNO - France
 Téléphone : +33 (0) 27 48 500 - contact@az-machinery.com - www.az-machinery.com
 Site : 624 654 958 666 19 - TVA : FR02 624 654 958 - N° EORI : FR02 624 654 958

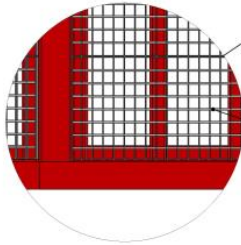
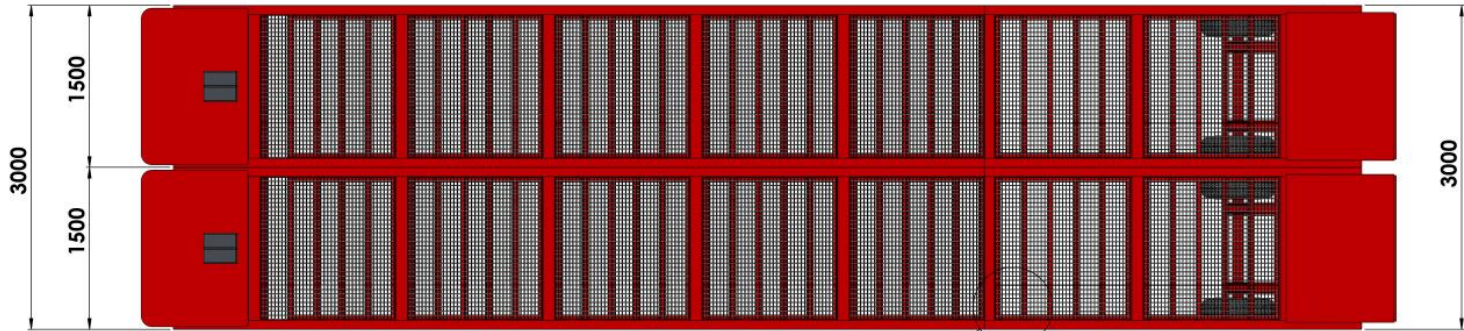
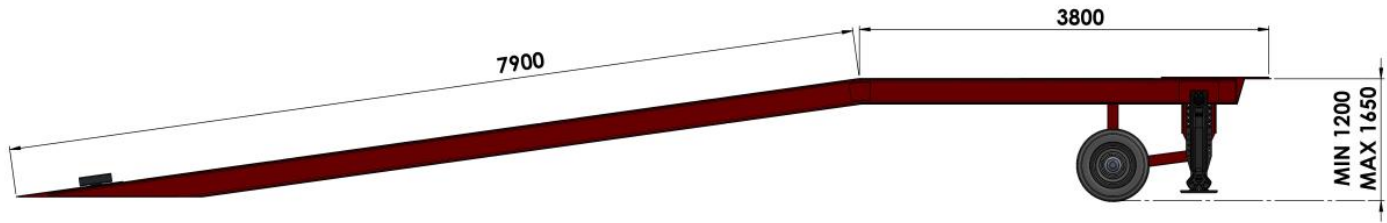

GALVANIZED GRID

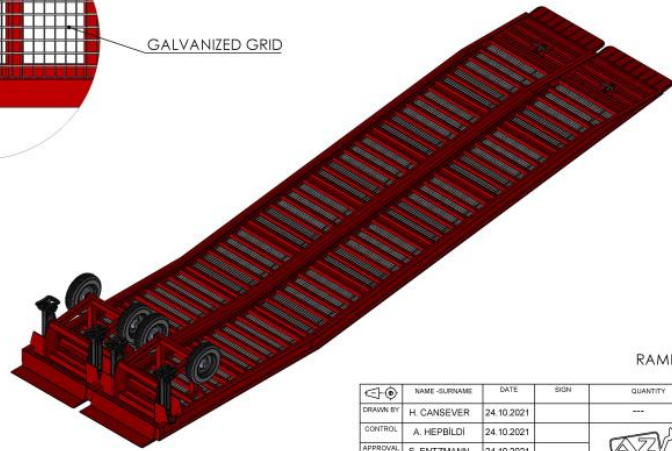
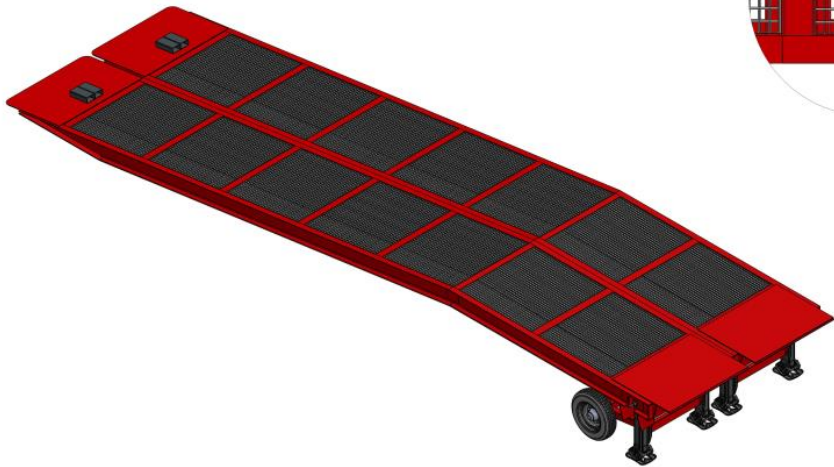

RAMP HAVE FOUR LEGS AND FOUR WHEELS

NAME - SURNAME	DATE	SIGN	QUANTITY	MASS (KG)	MATERIAL	PAGE/NO
DRAWN BY: H. CANSEVER	24.10.2021		---			1/1
CONTROL: A. HEPBILDI	24.10.2021					
APPROVAL: S. ENTZMANN	24.10.2021					
SCALE: 1:50						
PARTSSEMBLY NAME	DRAWING DESCRIPTION:		DRAWING NO.			
	AZ BIG KING FOOT 20 TONS		# 688B			

AZ MACHINERY - SLU, Matériels d'Élévation et Manutention
 13 rue de la source - 66360 PLAILLY DE CERDAGNE - France
 Téléphone : +33 (0) 37 48 500 - contact@az-machinery.com - www.az-machinery.com
 Site : 424 654 958 (6611) - TVA : FR02 824 654 958 - N° EORI : FR02 824 654 958



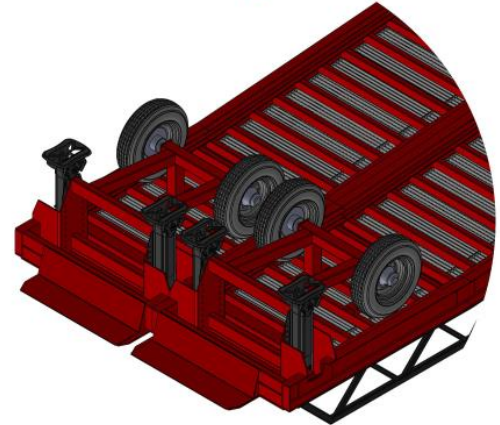
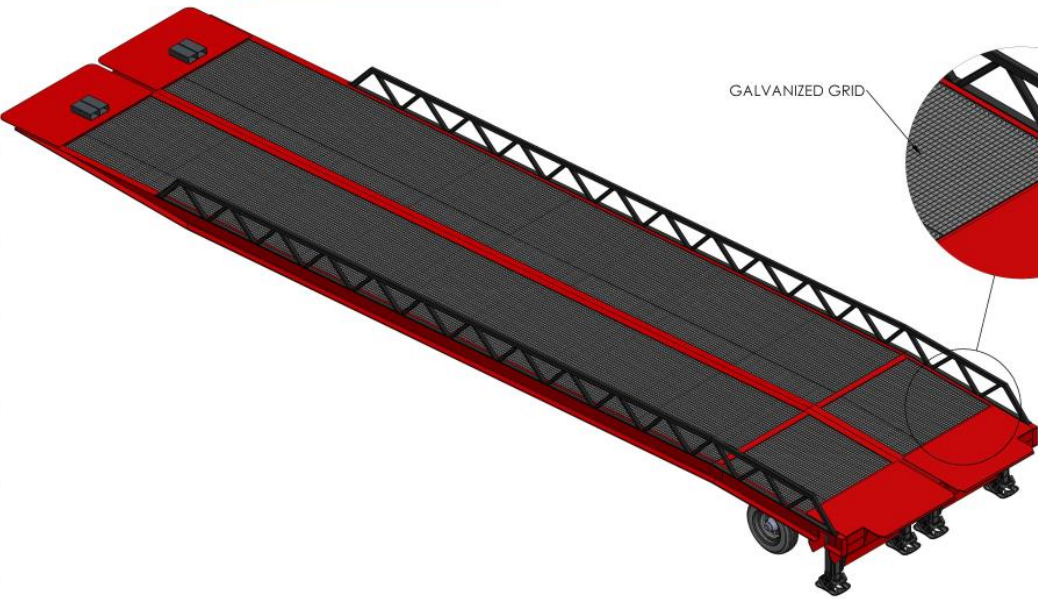
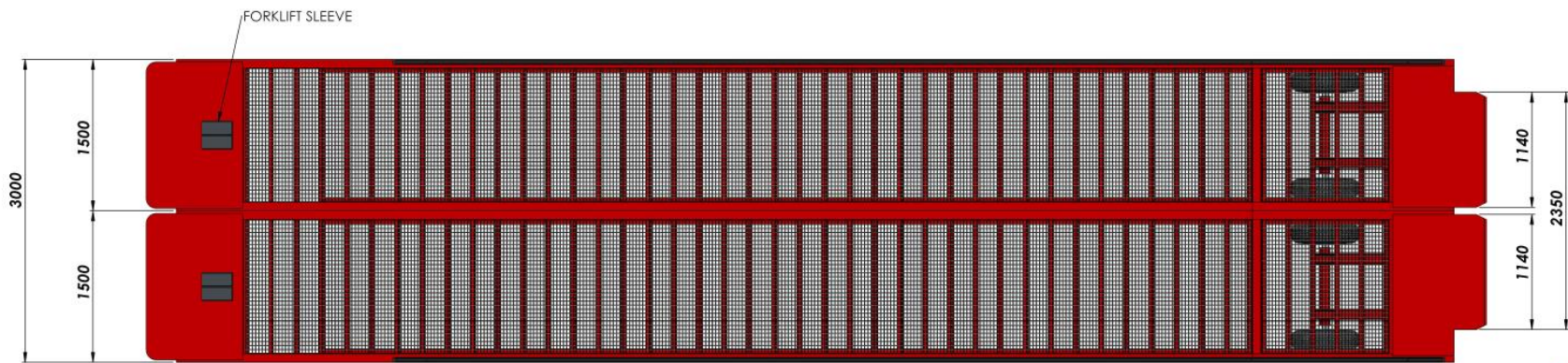
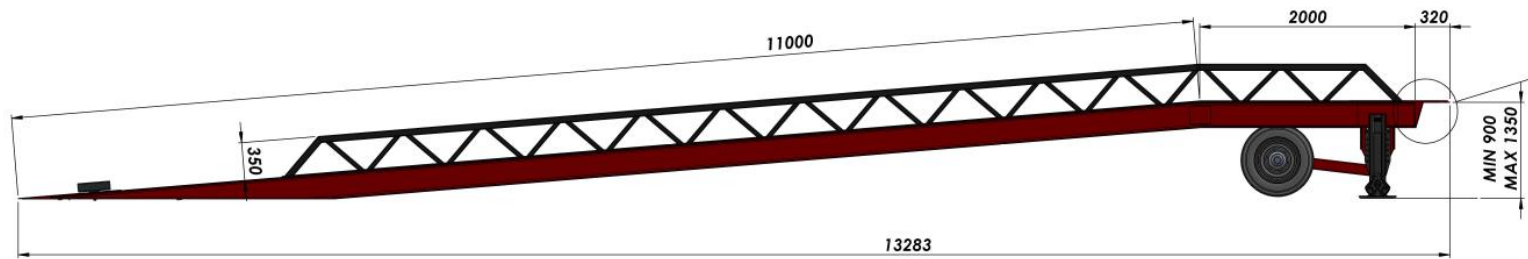

CAPACITY: 15 TONS

NAME - SURNAME	DATE	SIGN	QUANTITY	MASS (KG)	MATERIAL	PAGE NR
DRAWN BY: H. CANSEVER	30.03.2022		---			1/1
CONTROL: A. HEPBILDI	30.03.2022					
APPROVAL: S. ENTZMANN	30.03.2022					
SCALE: 1:50						
PART/ASSEMBLY NAME	DRAWING DESCRIPTION:		DRAWING NO.			
	#3WPK		--- #688B			



AZ MACHINERY - SLU, Matériels d'Élévation et Maintenance
 13 rue de la source - 36340 PALLATI DE CERBACONNE - France
 Téléphone : +33 (0) 27 46 500 - contact@az-machinery.com - www.az-machinery.com
 Site : 424 654 958 666 19 - TVA : FR02 824 654 958 - N° EORI : FR02 824 654 958

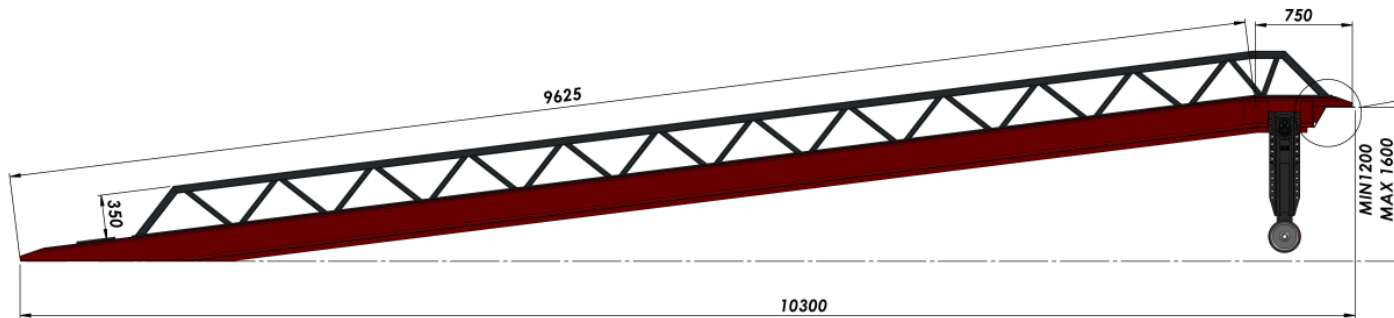

ALL FLOOR IS EXPANDED SHEET

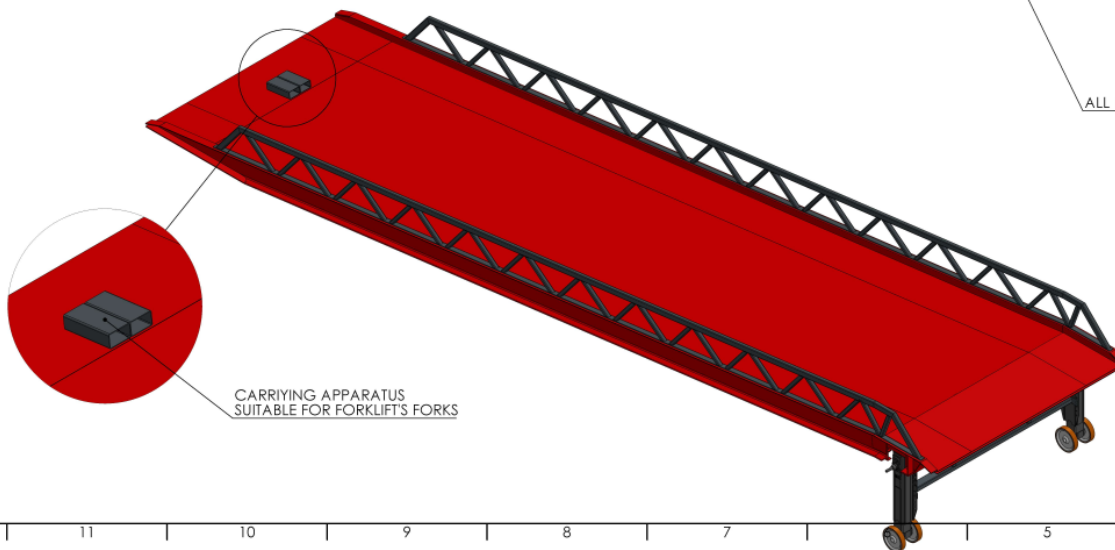

CARRYING APPARATUS
SUITABLE FOR FORKLIFT'S FORKS

NAME - SURNAME	DATE	SIGN	QUANTITY	MASS (KG)	MATERIAL	PAGE/NT
DRAWN BY: H. CANSEVER	11.01.2022		---			1/1
CONTROL: A. HEPBILDI	11.01.2022					
APPROVAL: S. ENTZMANN	11.01.2022					
SCALE: 1:50						
PART/ASSEMBLY NAME	DRAWING DESCRIPTION		DRAWING NO.			
	PRIME 10-10 WITH RAILGUARD		---			



AZ MACHINERY - SLU, Matériels d'Élévation et Manutention
 13 rue de la scierie - 46340 PALLAT - FRANCE
 Téléphone : +33 (0) 27 48 500 - contact@az-machinery.com - www.az-machinery.com
 Site : 424 654 958 000 FR - TVA : FR02 424 654 958 - N° EORI : FR42 424 654 958

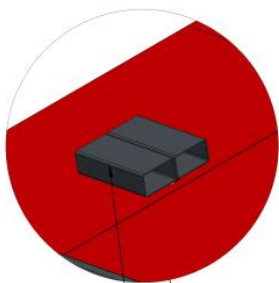
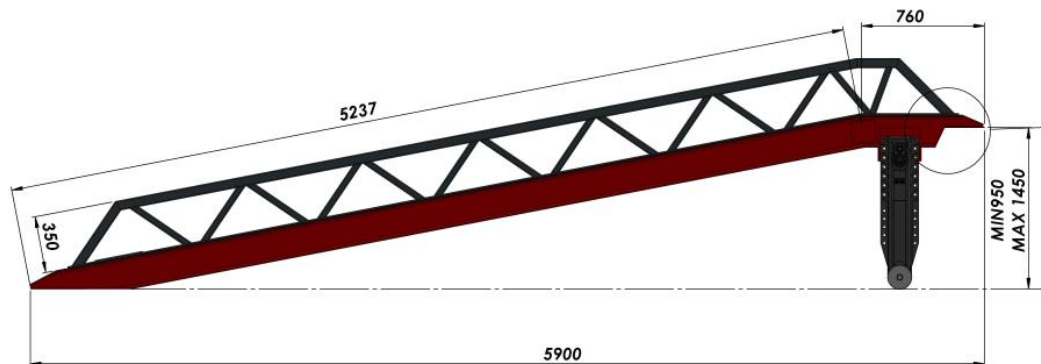

CARRYING APPARATUS
SUITABLE FOR FORKLIFT'S FORKS

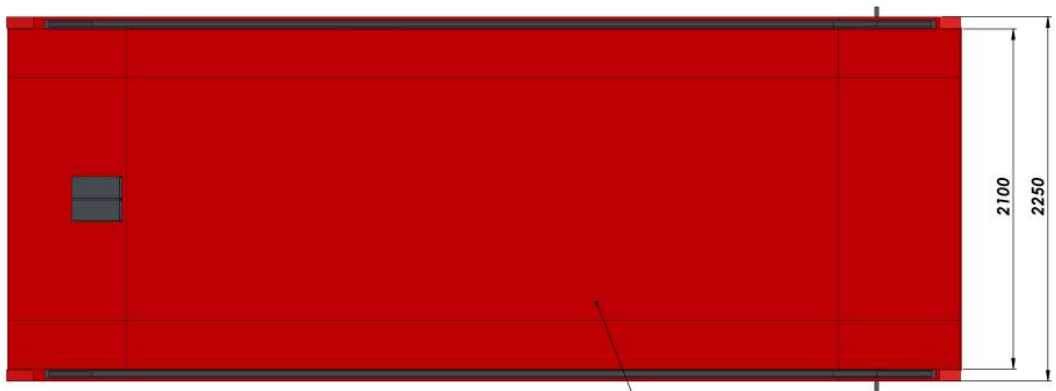

ALL FLOOR IS EXPANDED SHEET

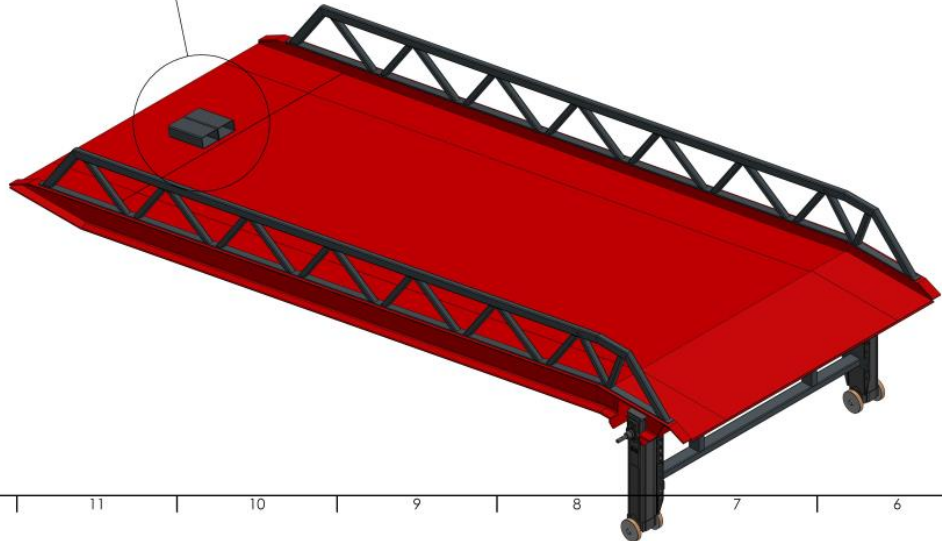

NAME - SURNAME	DATE	SIGN	QUANTITY	MASS (KG)	MATERIAL	PAGE NR
DRAWN BY: H. CANSEVER	11.01.2022		---			1/1
CONTROL: A. HEPBILDI	11.01.2022					
APPROVAL: S. ENTZMANN	11.01.2022					
SCALE: 1:50						
PART/ASSEMBLY NAME			DRAWING DESCRIPTION		DRAWING NO.	
			PRIME-XS6 WITH RAILGUARD		---	



AZ MACHINERY - SLU, Matériels d'Élévation et Maintenance
 13 rue de la scierie - 66340 PALLATI DE CERDACHES - France
 Téléphone : +33 (0) 37 48 300 - contact@az-machinery.com - www.az-machinery.com
 Site : 424 654 958 666 19 - TVA : FR02 824 654 958 - N° EORI : FR02 824 654 958

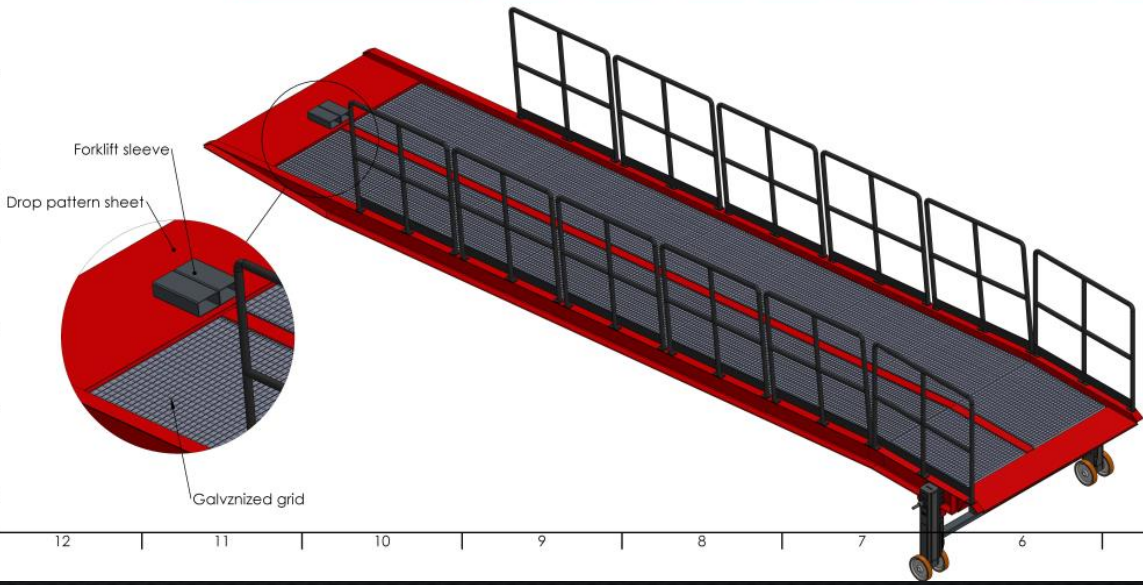
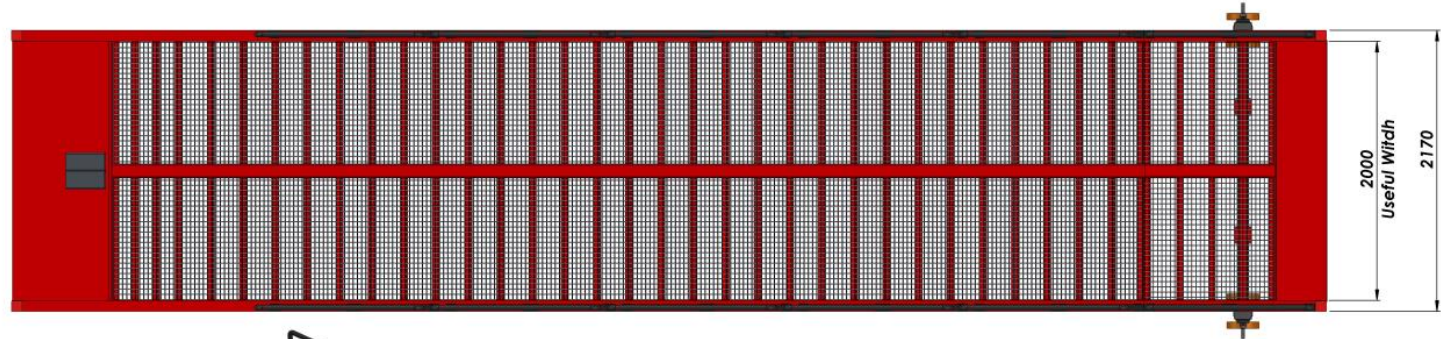
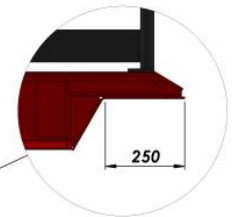
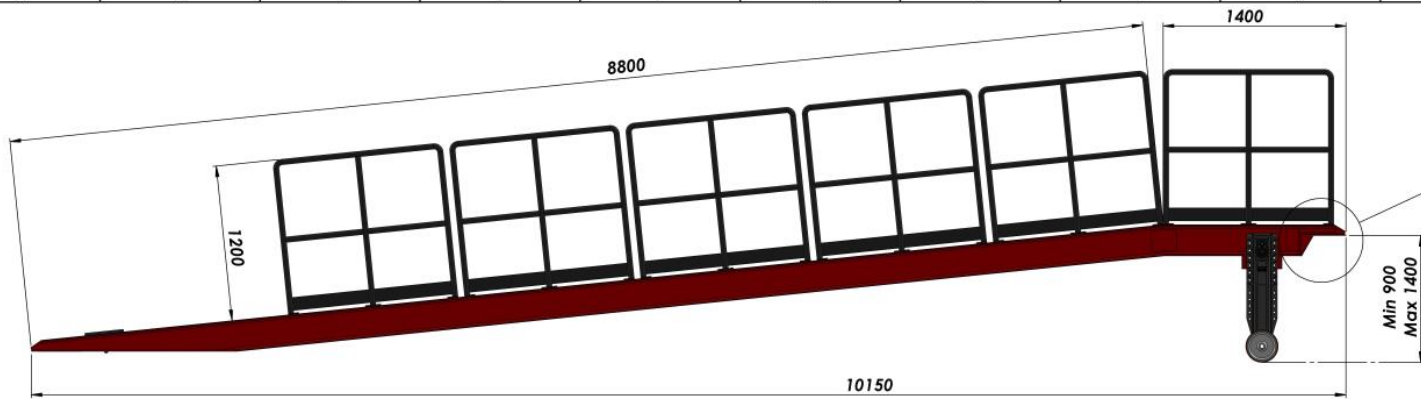

NAME - SURNAME	DATE	SIGN	QUANTITY	MASS (KG)	MATERIAL	PAGE/NO
DRAWN BY: H. CANSEVER	30.05.2022		---			1/1
CONTROL: A. HEPBILDI	30.05.2022					
APPROVAL: S. ENTZMANN	30.05.2022					
SCALE: 1:50						
PART/ASSEMBLY NAME			DRAWING DESCRIPTION		DRAWING NO.	
			PRIME WLO WITH 1200 RL		---	



AZ MACHINERY - SLU, Matériels d'Élévation et Manutention
 13 rue de la scierie - 56 340 PLATRI DE CERBACHES - France
 Téléphone : +33 (0) 27 48 300 - contact@az-machinery.com - www.az-machinery.com
 Site : 424 654 958 666 19 - TVA : FR02 424 654 958 - N° EORI : FR02 424 654 958

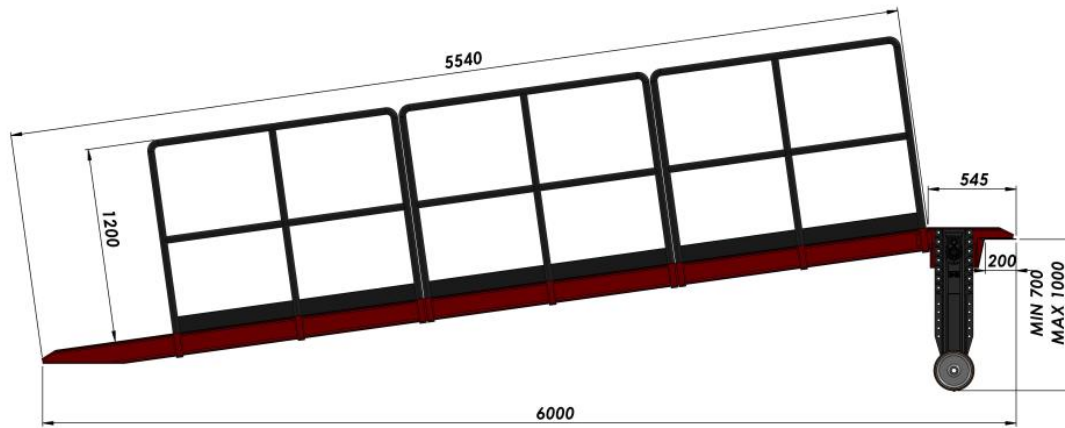

ALL FLOOR IS DROP PATTERN SHEET

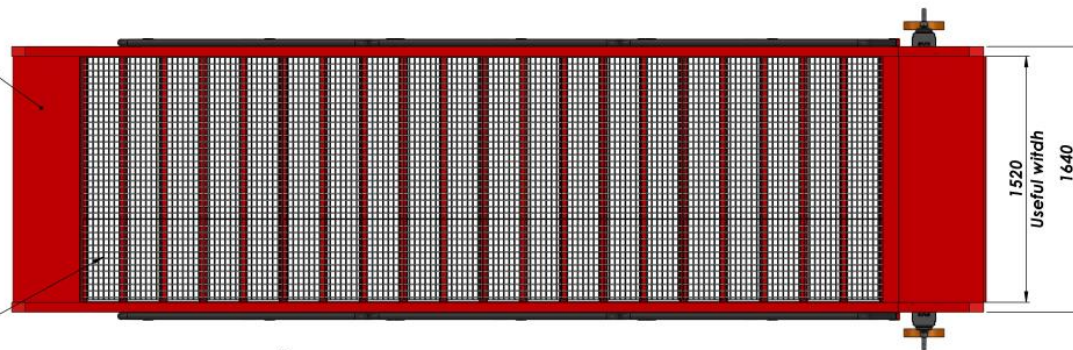

GALVANIZED GRID

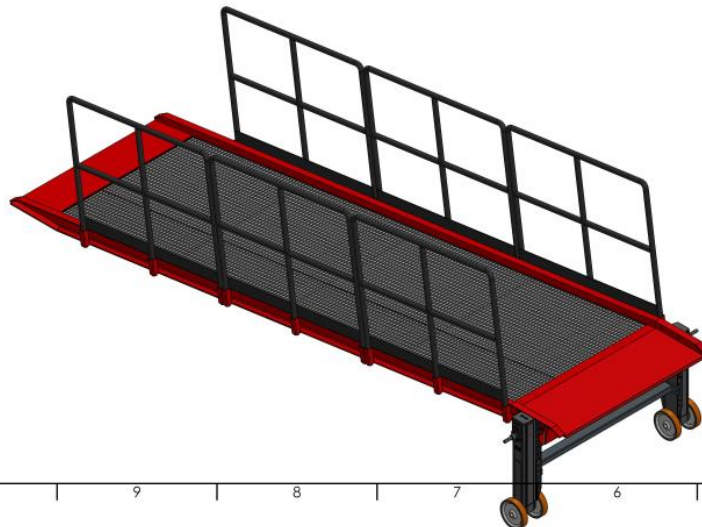

CAPACITY: 3000 KG

NAME-SURNAME	DATE	SIGN	QUANTITY	MASS (KG)	MATERIAL	PAGE NR
DRAWN BY: H. CANSEVER	26.04.2022		---			1/1
CONTROL: A. HEPBILDI	26.04.2022					
APPROVAL: S. ENTZMANN	26.04.2022					
SCALE: 1:50						
PARTS/ASSEMBLY NAME			DRAWING DESCRIPTION		DRAWING NO.	
			#TS98 Ramp for commercial vehicles		---	



AZ MACHINERY - SLU, Matériels d'Élévation et Maintenance
 13 rue de la scierie - 66340 PALLAS DE CERDAGNE - France
 Téléphone : +33 (0) 37 48 300 - contact@az-machinery.com - www.az-machinery.com
 Site : 424 654 958 606 19 - TVA : FR02 824 654 958 - N° EORI : FR02 824 654 958



DRAWINGS

Rampes mobiles

Rampes fixes

Plateformes logistiques

Réhausse

Tables de quai mobiles

Tables de quai fixes

Passerelles

Rampes pour conteneurs

Niveleurs

Autres confections

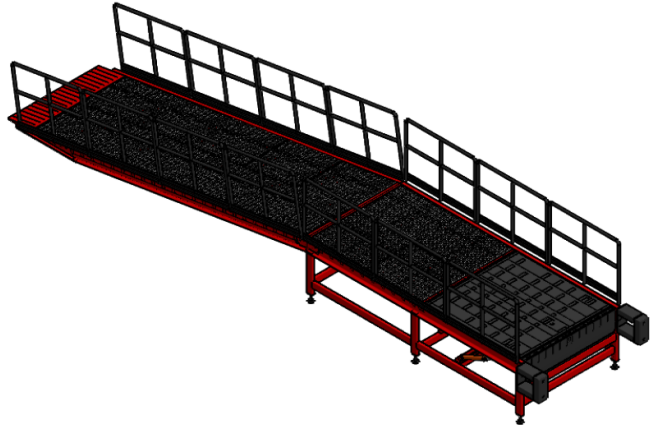
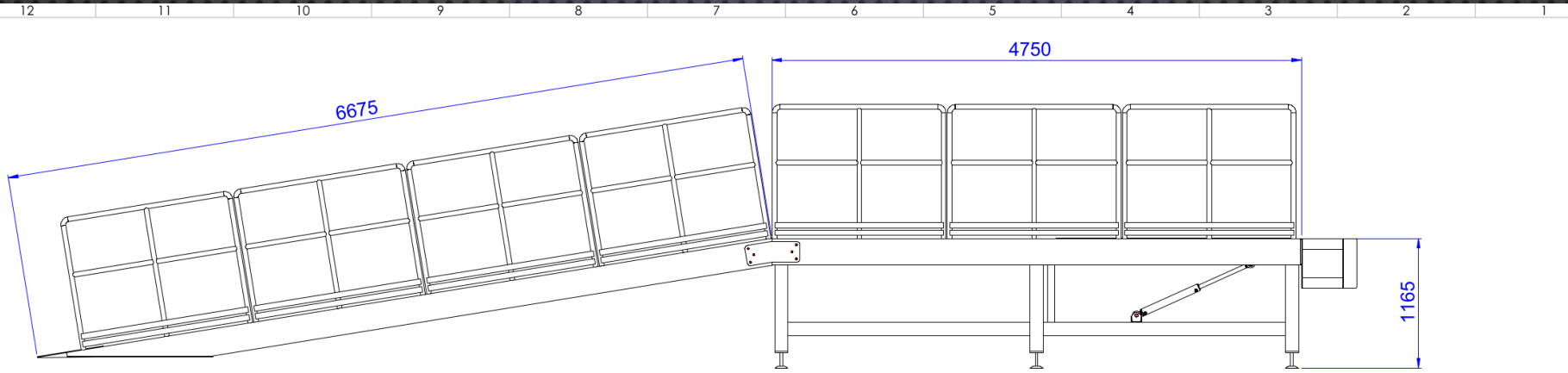

ADI - SOYADI NAME - SURNAME	TARİH DATE	İMZA SIGN	MİKTAR QUANTITY	AĞIRLIK (KG) MASS (KG)	MALZEME MATERIAL	SAYFA NO PAGE NO
N HATİPOĞLU	04/12/2020		---			1/1
KONTROL CONTROL	H.CANSEVER	04/12/2020				
ONAY APPROVAL	A.HEPBİLDİ	04/12/2020				
ÖLÇEK SCALE	1:25					
PARÇAMONTAJ ADI PART/ASSEMBLY NAME	TEKNİK RESİM AÇIKLAMASI DRAWING DESCRIPTION				RESİM NO DRAWING NO	
	FRA-ORD-25				---	2 2



AZ MACHINERY - SLU, Matériels d'Élévation et Manutention
13 rue de la scierie - 05 340 PÉLASSIÈRE CÉREZIENNE - France
Téléphone : +33 97 37 46 100 - contact@az-machinery.com - www.az-machinery.com
Site : S24-054-958-000 19 - TVA : FR02 824 654 958 - N° EORI : FR02 824 654 958

12 11 10 9 8 7 6 5 4 3 2 1

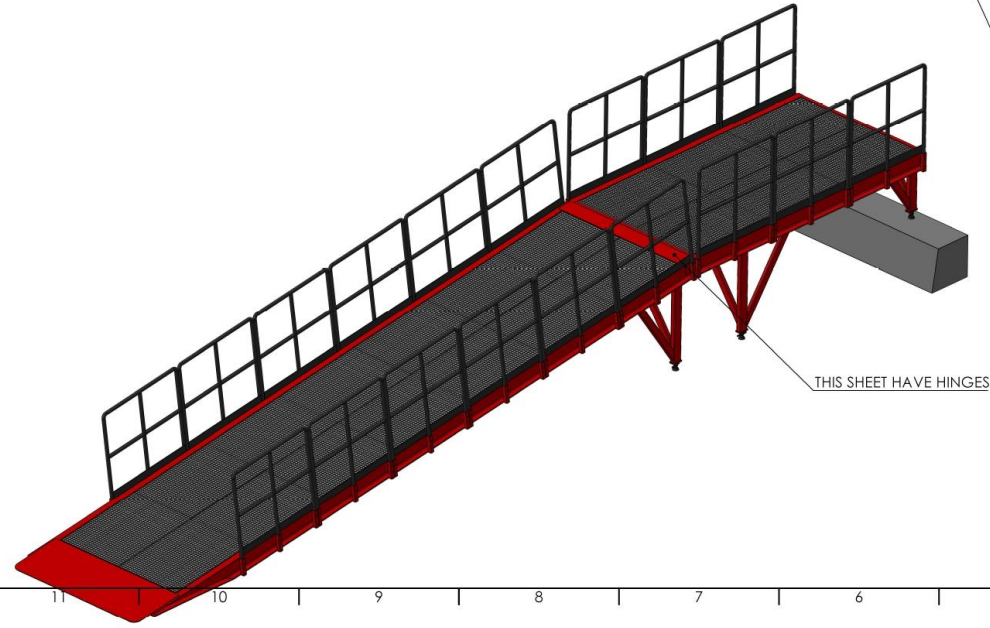
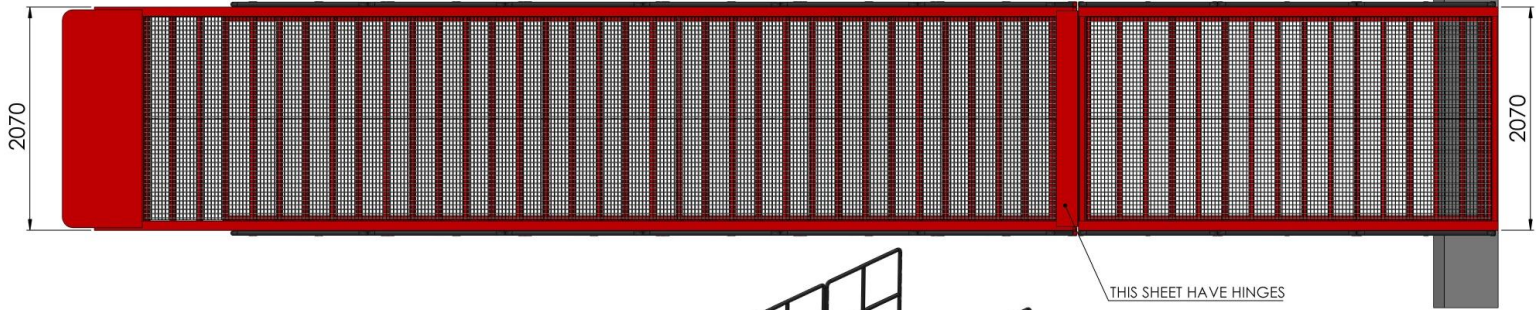
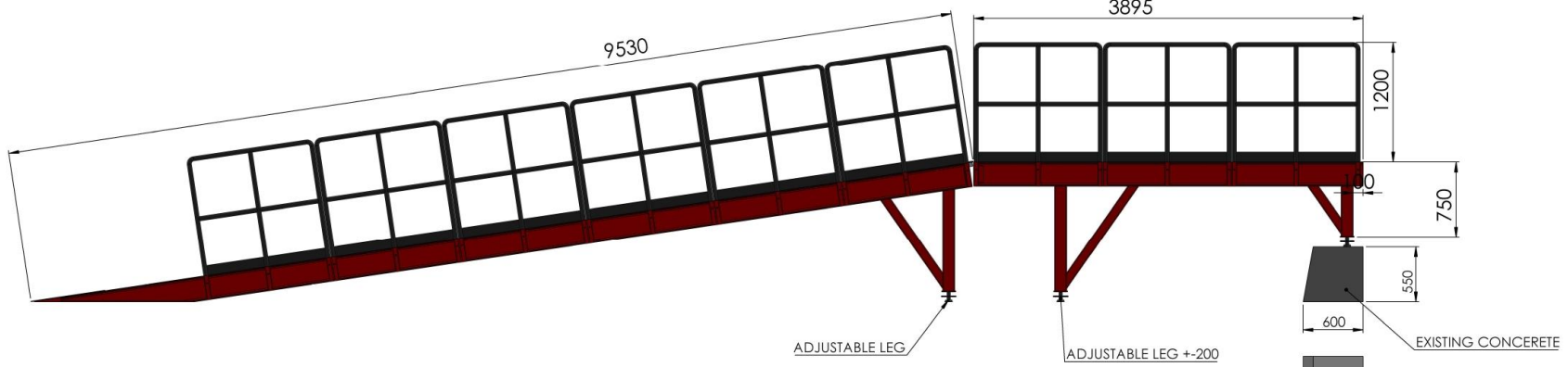

NAME - SURNAME	DATE	SIGN	QUANTITY	MASS (KG)	MATERIAL	PAGE NR
DRAWN BY H. CANSEVER	10.07.2021		---			1/1
CONTROL A. HEPBILDI	10.07.2021					
APPROVAL J. GUGUET	10.07.2021					
SCALE 1:50						
PARTIASSSEMBLY NAME			DRAWING DESCRIPTION		DRAWING NO	
			FIX DOCK LAYOUT		---	

AZ MACHINERY - SLU, Matériels d'Élévation et Manutention
 13 rue de la scierie - 06 540 PALAÏ DE CERDAGNIEN - France
 Téléphone : +33 (0) 27 46 509 - contact@az-machinery.com - www.az-machinery.com
 Site : S24 654 958 000 19 - TVA : FR02 824 654 958 - N° FORET : FRAD 824 654 958

12 11 10 9 8 7 6 5 4 3 2 1

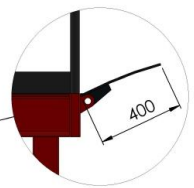
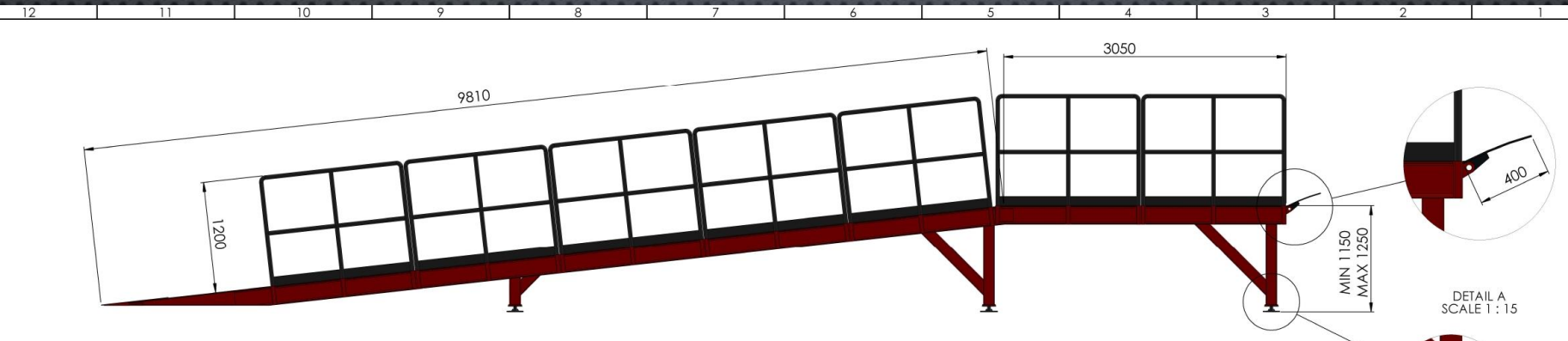

DETAIL A
SCALE 1 : 15

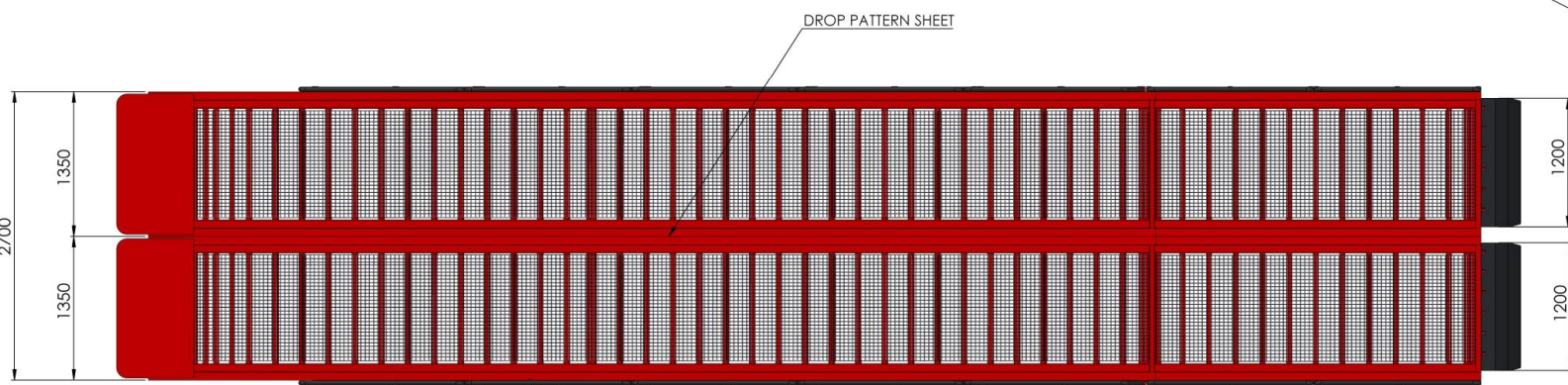

DETAIL B
SCALE 1 : 15
ADJUSTABLE LEG

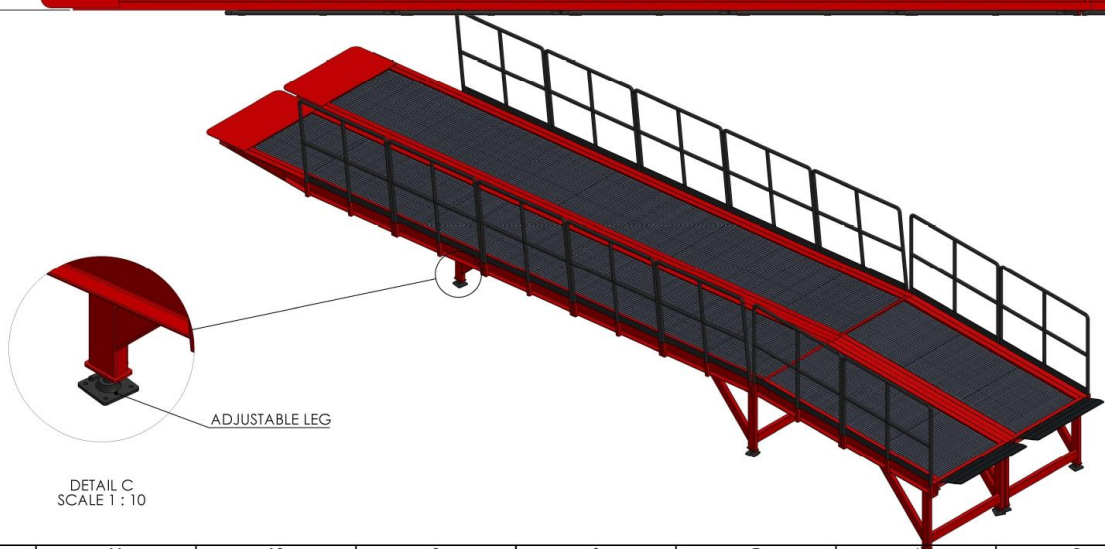

DETAIL C
SCALE 1 : 10

NAME-SURNAME	DATE	SIGN	QUANTITY	MASS (KG)	MATERIAL	PAGE NR
DRAWN BY H. CANSEVER	27.07.2021		---			1/1
CONTROL A. HEPBILDI	27.07.2021					
APPROVAL S. ENTZMANN	27.07.2021					
SCALE 1:50						
PARTASSEMBLY NAME		DRAWING DESCRIPTION		DRAWING NO		
		FRA-ORD-53		---		



AZ MACHINERY - SLU, Matériels d'Élévation et Maintenance
 13 rue de la scierie - 66 540 PALLATI DE CERDAGNÈ - France
 Téléphone : +33 (0) 27 46 505 - contact@az-machinery.com - www.az-machinery.com
 Site : S24 654 958 000 TVA - FR02 S24 654 958 - NF E061 - FRAD S24 654 958

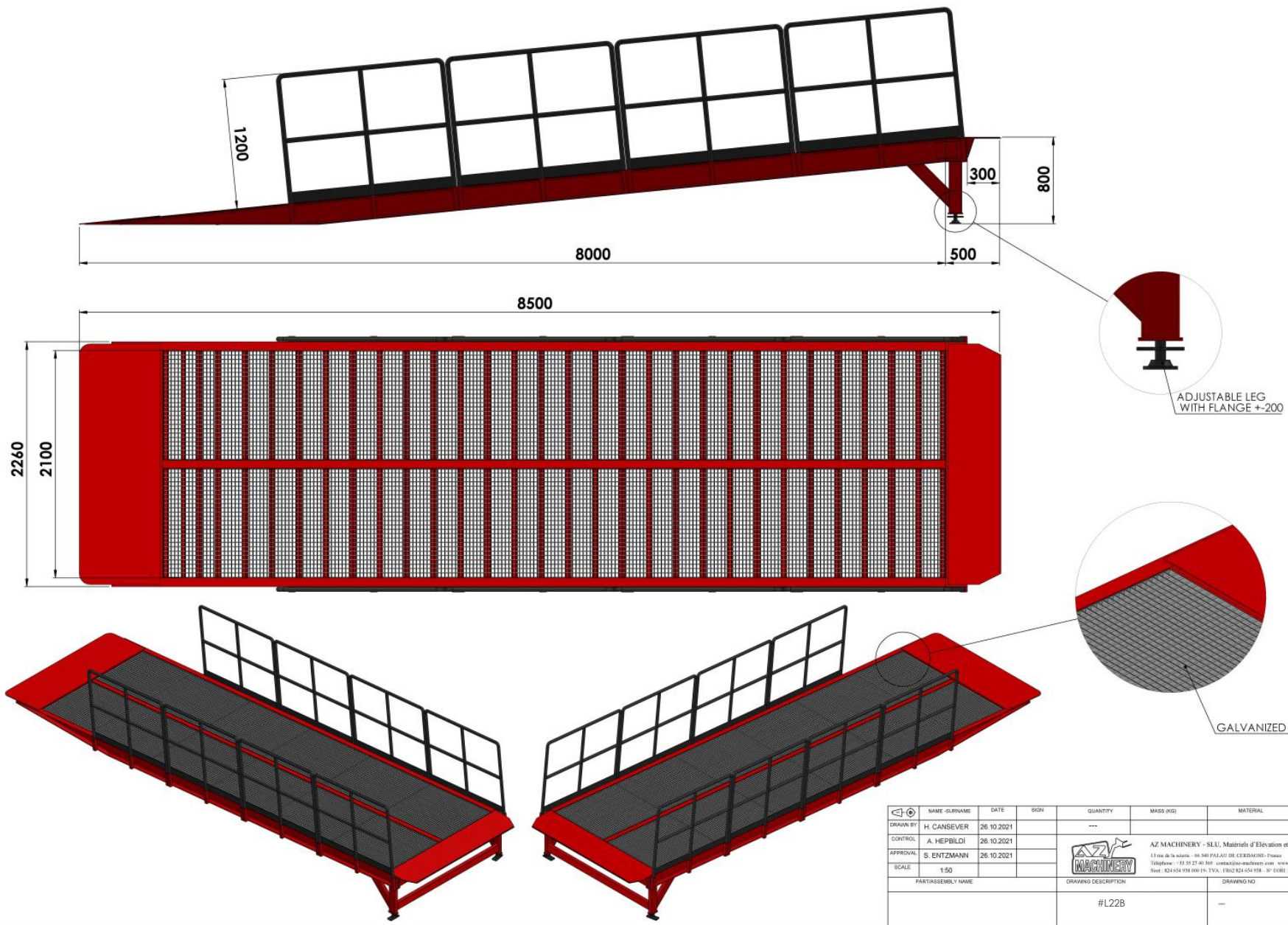

NAME - SURNAME	DATE	SIGN	QUANTITY	MASS (KG)	MATERIAL	PAGE/NT
DRAWN BY H. CANSEVER	26.10.2021		---			1/1
CONTROL A. HEPBILDI	26.10.2021					
APPROVAL S. ENTZMANN	26.10.2021					
SCALE 1:50						
PART/ASSEMBLY NAME			DRAWING DESCRIPTION		DRAWING NO.	
			#L22B		---	

AZ MACHINERY - SLU, Matériels d'Élévation et Maintenance
13 rue de la source - 16 540 PALLAS DE CEBERAKORN - France
Téléphone : +33 (0) 37 48 500 - contact@az-machinery.com - www.az-machinery.com
Site : 824 654 958 000 FR - TVA : FR02 824 654 958 - 3° E000 - FR02 824 654 958

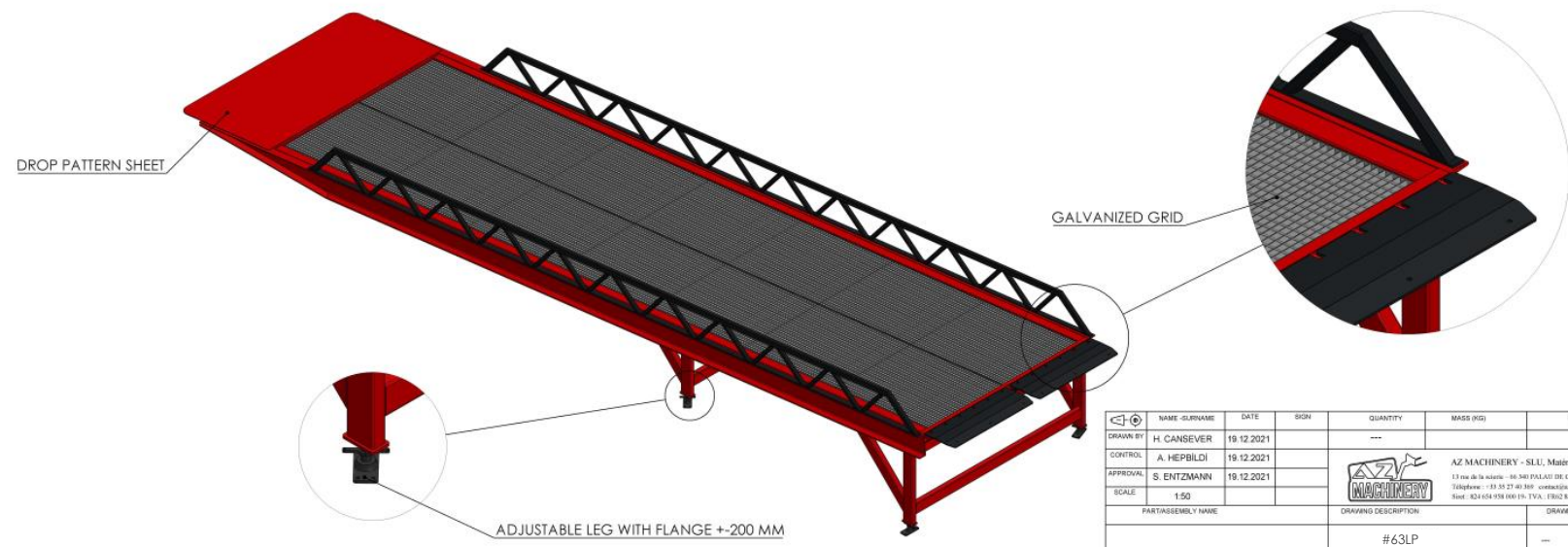
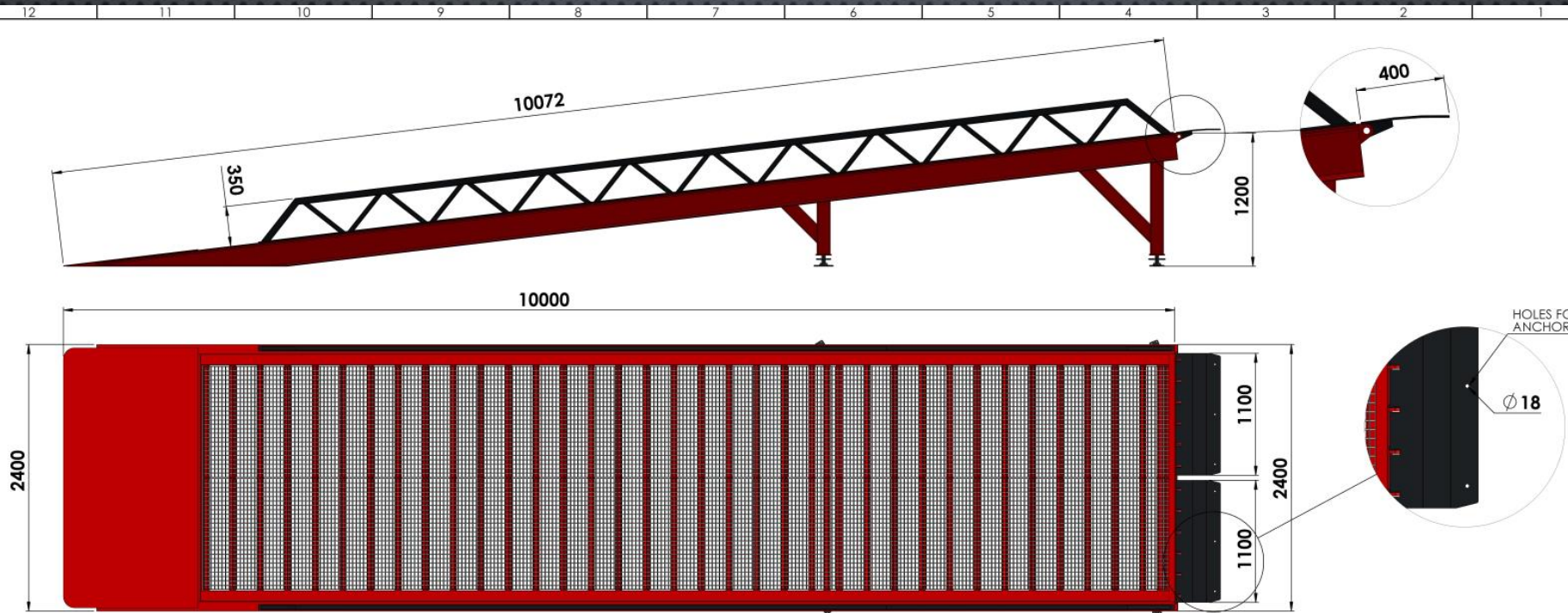

NAME - SURNAME	DATE	SIGN	QUANTITY	MASS (KG)	MATERIAL	PAGE/NT
DRAWN BY: H. CANSEVER	19.12.2021		---			1/1
CONTROL: A. HEPBILDI	19.12.2021					
APPROVAL: S. ENTZMANN	19.12.2021					
SCALE: 1:50						
PARTS/ASSEMBLY NAME			DRAWING DESCRIPTION:		DRAWING NO.	
			#63LP		---	

AZ MACHINERY

AZ MACHINERY - SLU, Matériels d'Élévation et Maintenance
 13 rue de la source - 16 540 PÉLLESTRI DE CÉBERNARDIS - France
 Téléphone : +33 (0) 37 46 500 - contact@az-machinery.com - www.az-machinery.com
 Site : 824 654 958 000 FR - TVA : FR02 824 654 958 - 3^e EORL - REAO 824 654 958

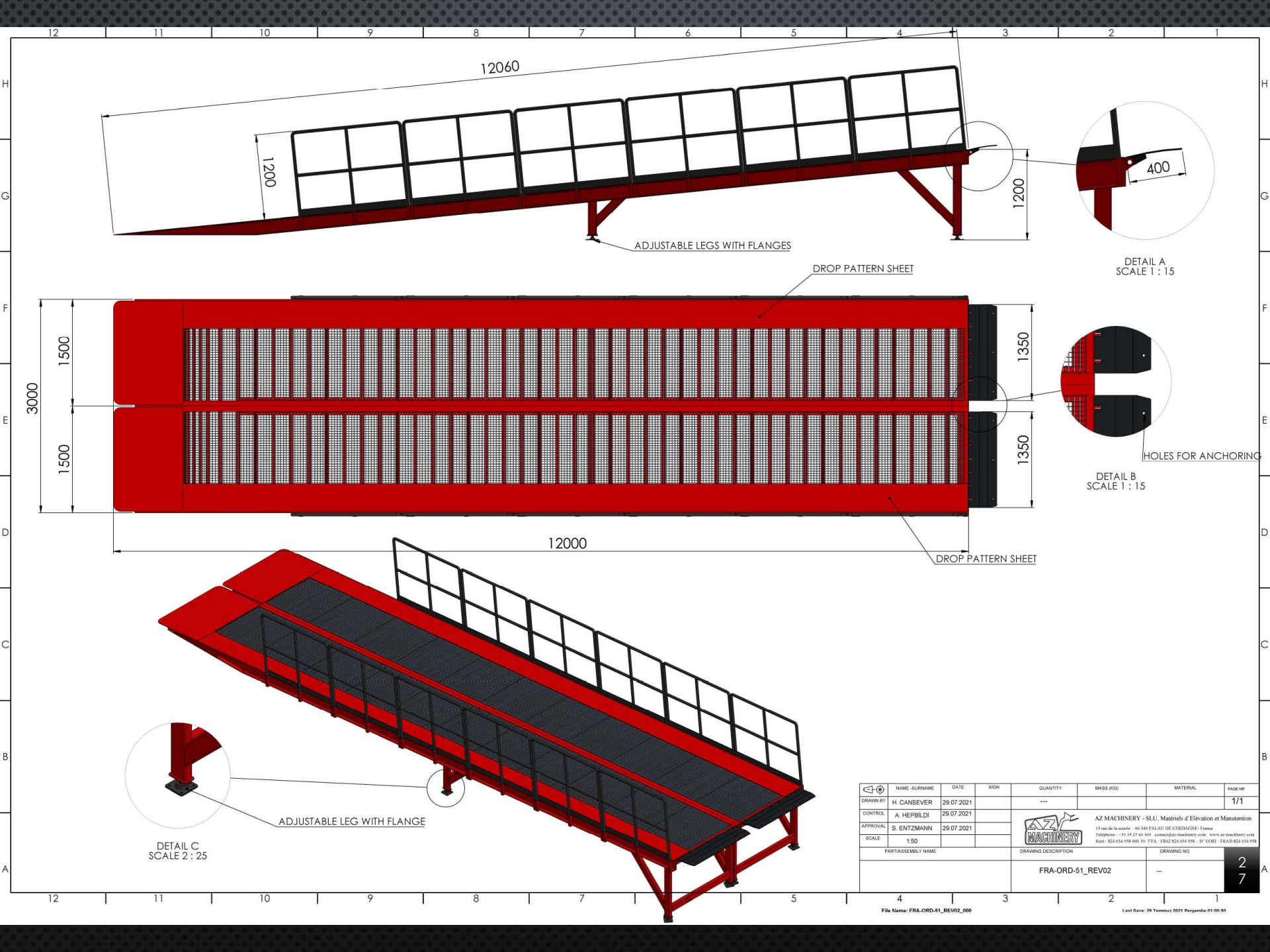

12060

1200

1200

DETAIL A
SCALE 1 : 15

ADJUSTABLE LEGS WITH FLANGES

DROP PATTERN SHEET

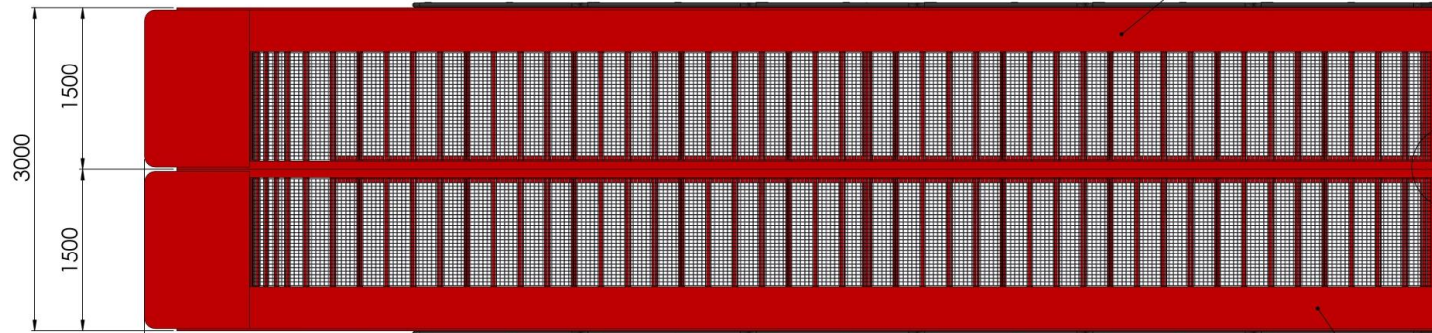

3000

1500

1500

12000

1350

1350

DROP PATTERN SHEET

HOLES FOR ANCHORING

DETAIL B
SCALE 1 : 15

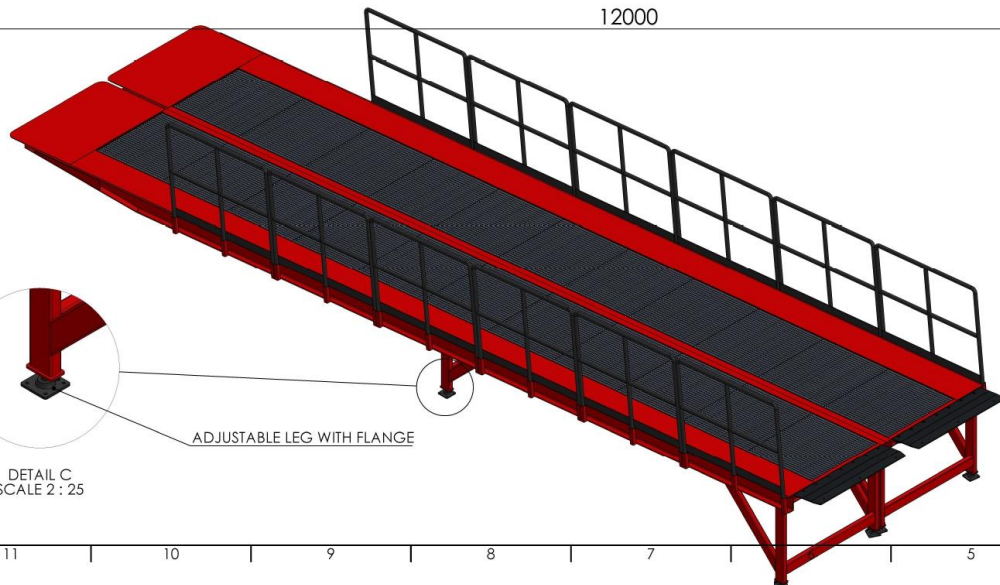

ADJUSTABLE LEG WITH FLANGE

DETAIL C
SCALE 2 : 25

NAME-SURNAME	DATE	SIGN	QUANTITY	MASS (KG)	MATERIAL	PAGE NR
DRAWN BY H. CANSEVER	29.07.2021		---			1/1
CONTROL A. HEPBILDI	29.07.2021					
APPROVAL S. ENTZMANN	29.07.2021					
SCALE 1:50						
PART/ASSEMBLY NAME		DRAWING DESCRIPTION		DRAWING NO		
		FRA-ORD-51_REV02		---		



AZ MACHINERY - SLU, Matériels d'Élévation et Manutention
13 rue de la scierie - 66 540 PALAÏ DE CERDANNEN - France
Téléphone : +33 37 27 40 509 - contact@az-machinery.com - www.az-machinery.com
Site : S24 654 958 000 FR - TVA : FR02 S24 654 958 - N° FORET : FRAD S24 654 958

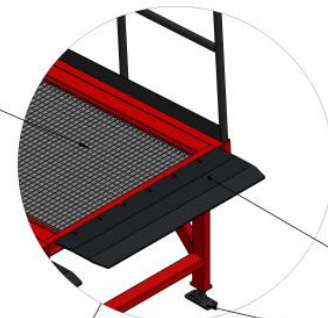
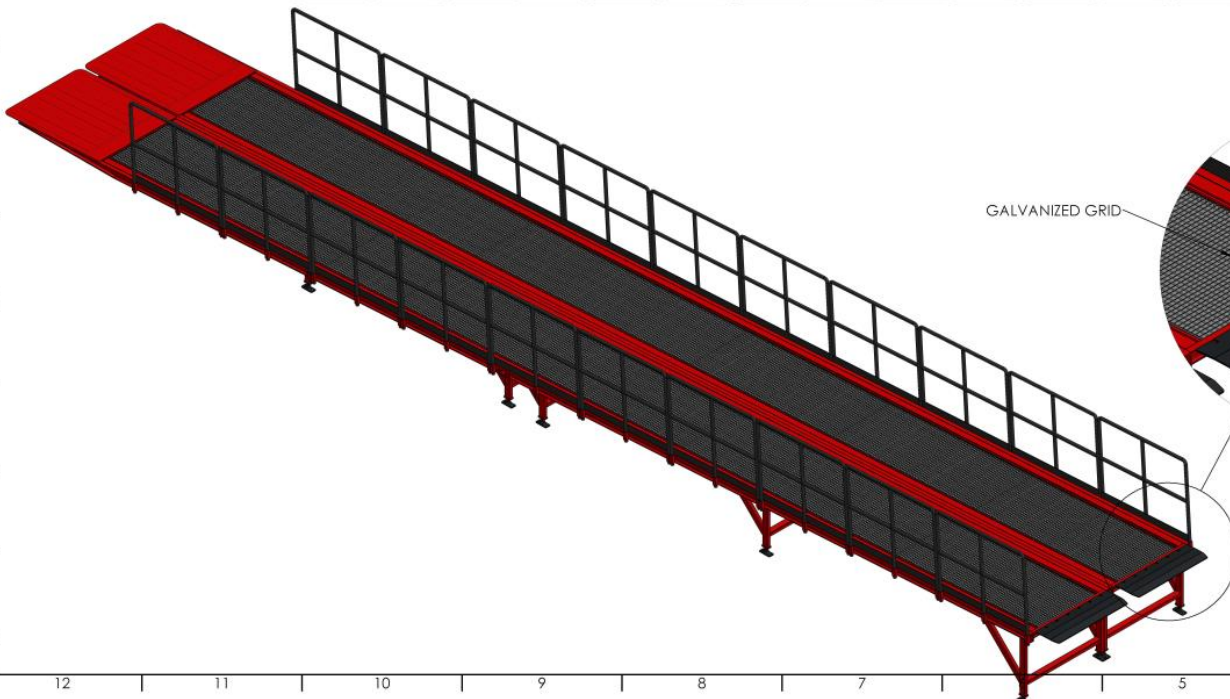
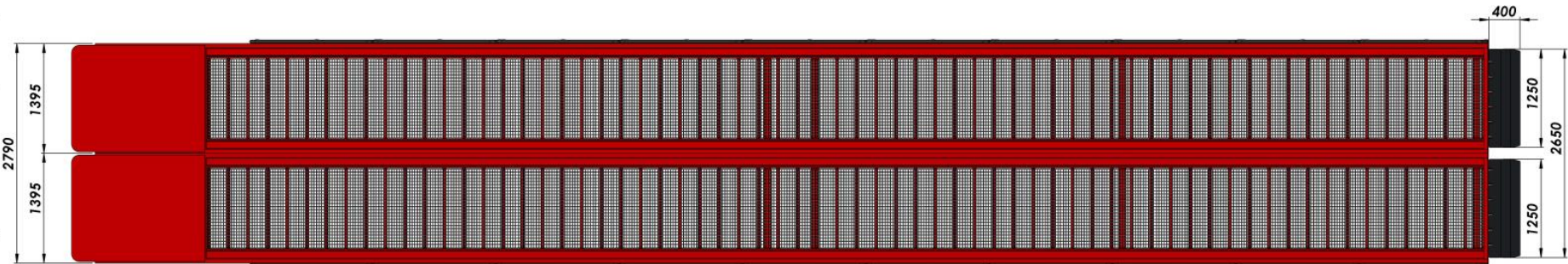
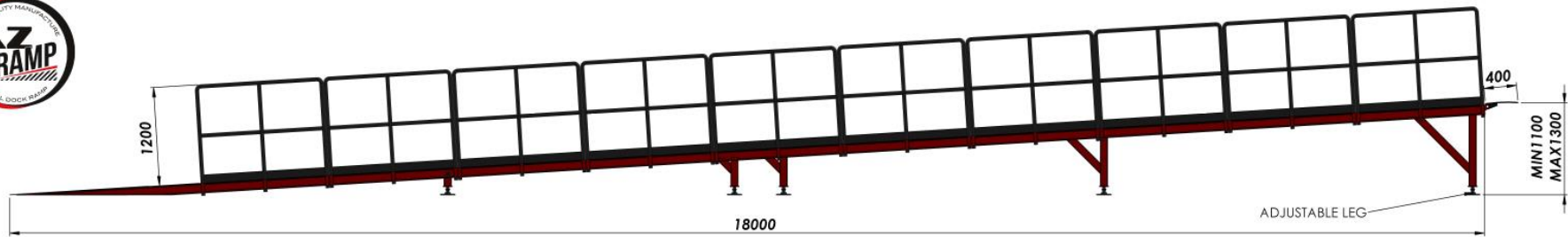

CAPACITY: 1500 KG

NAME - SURNAME	DATE	SIGN	QUANTITY	MASS (KG)	MATERIAL	PAGE/MT
DRAWN BY: H. CANSEVER	25.04.2022		---			1/1
CONTROL: A. HEPBILDI	25.04.2022					
APPROVAL: S. ENTZMANN	25.04.2022					
SCALE: 1:50						
PART/ASSEMBLY NAME	DRAWING DESCRIPTION		DRAWING NO.			
	#TA8Q		---			



AZ MACHINERY - SLU, Matériels d'Élévation et Maintenance
 13 rue de la source - 46 540 PULVILLI DE CEEBACHEN - France
 Téléphone : +33 (0) 37 48 500 - contact@az-machinery.com - www.az-machinery.com
 Site : 824 654 958 000 FR - TVA : FR02 824 654 958 - 3° EORI : FR02 824 654 958

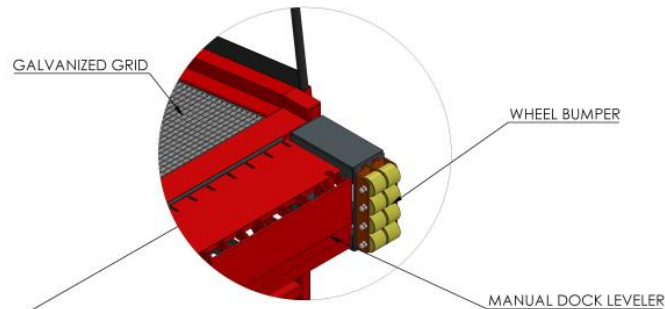
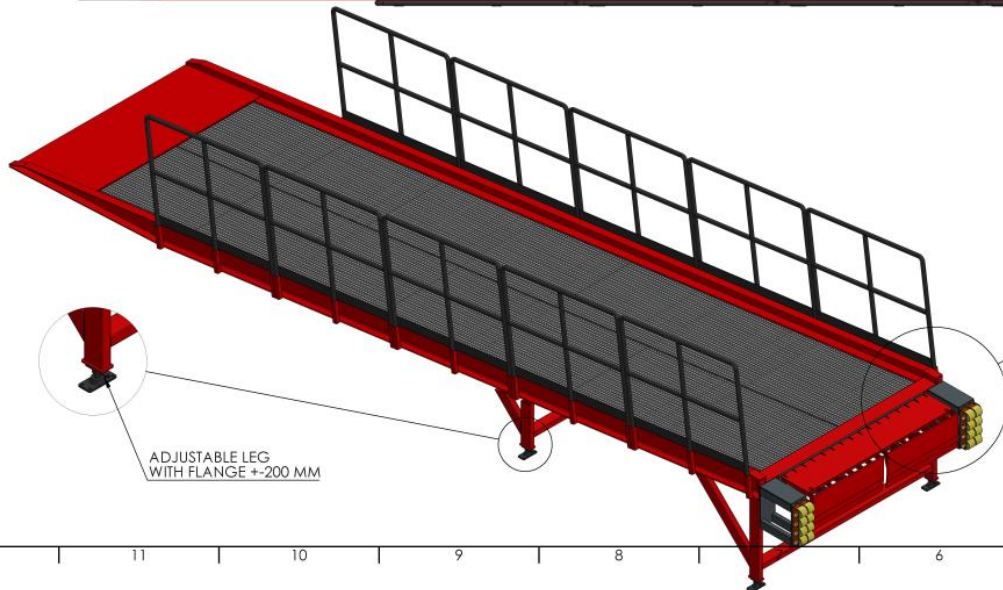
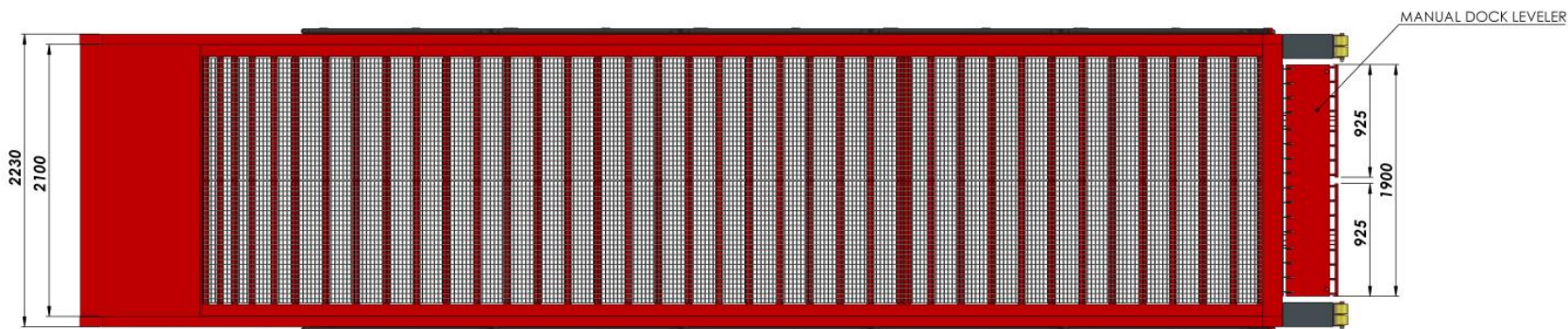
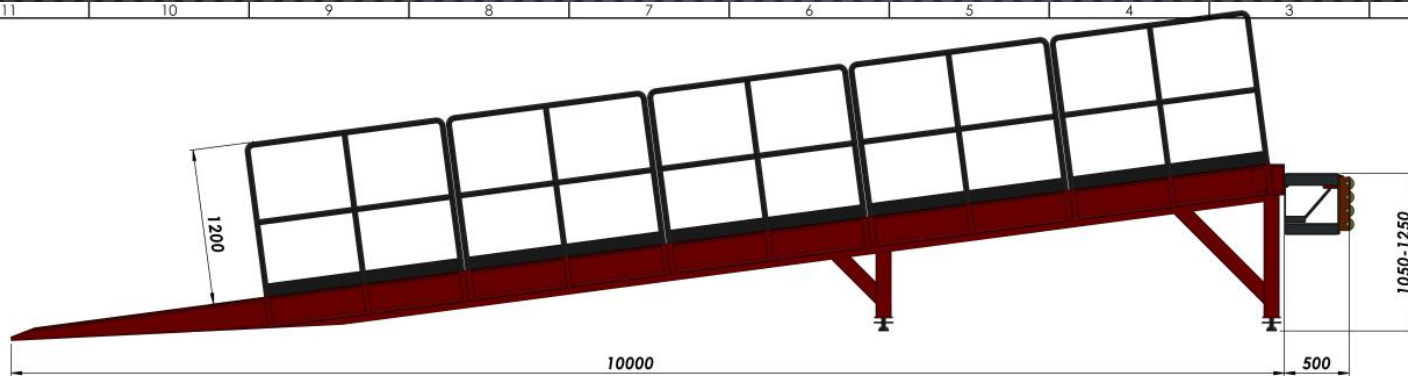

ADJUSTABLE LEG WITH FLANGE +200 MM

NAME - SURNAME	DATE	SIGN	QUANTITY	MASS (KG)	MATERIAL	PAGE/NT
DRAWN BY H. CANSEVER	01.02.2022		---			1/1
CONTROL A. HEPBILDI	01.02.2022					
APPROVAL S. ENTZMANN	01.02.2022					
SCALE 1:50						
PART/ASSEMBLY NAME	DRAWING DESCRIPTION		DRAWING NO.			
	#73RK		---			



AZ MACHINERY - SLU, Matériels d'Élévation et Maintenance
 13 rue de la scierie - 46 540 PULVILLIÈRE DE CÉREBIANVILLE - France
 Téléphone : +33 (0) 37 48 500 - contact@az-machinery.com - www.az-machinery.com
 Site : 424 654 958 000 FR - TVA : FR02 824 654 958 - 3^e EORL - REA3 824 654 958

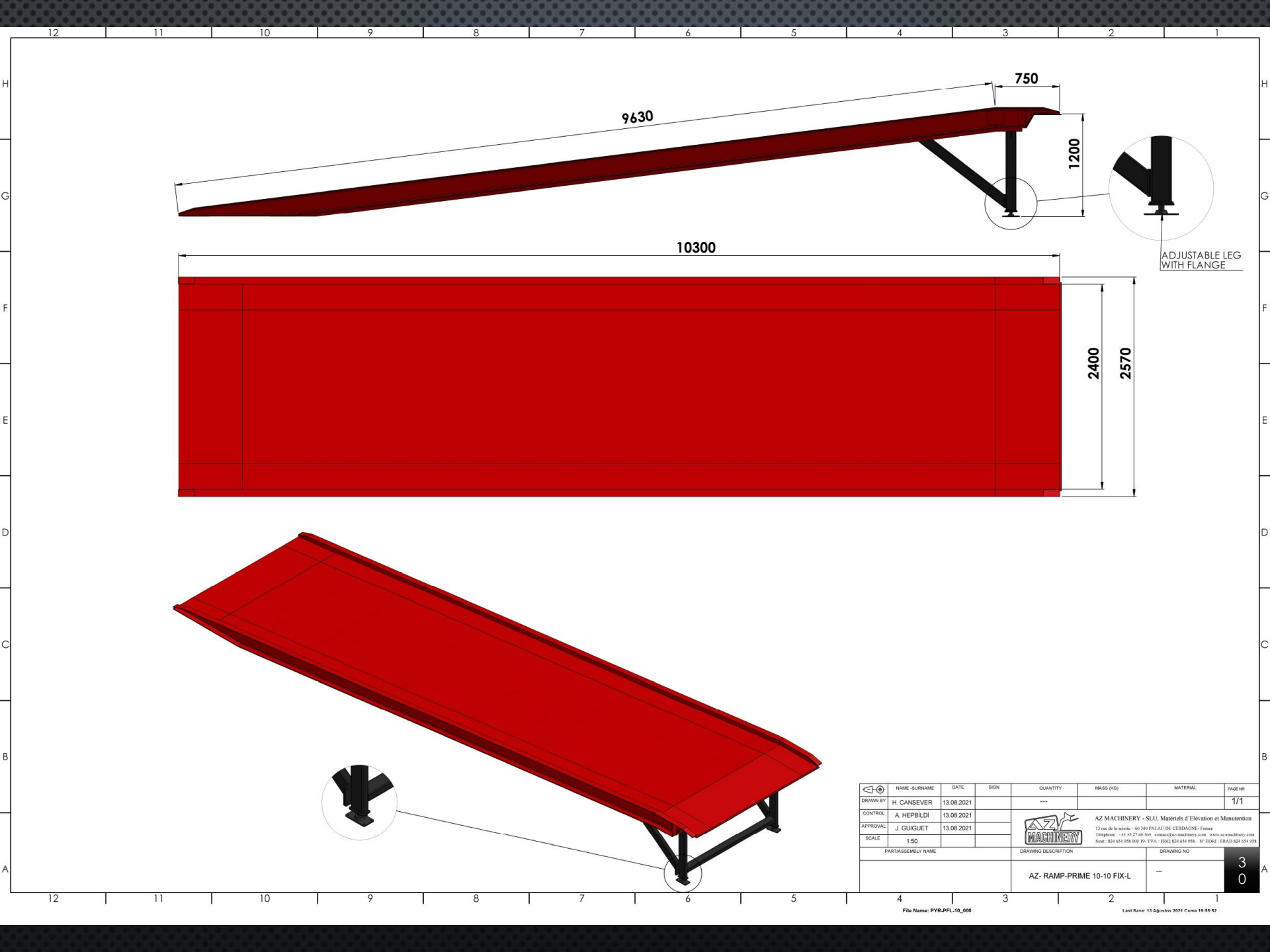

ADJUSTABLE LEG WITH FLANGE

NAME-SURNAME	DATE	SIGN	QUANTITY	MASS (KG)	MATERIAL	PAGE NR
DRAWN BY H. CANSEVER	13.08.2021		---			1/1
CONTROL A. HEPBILDI	13.08.2021					
APPROVAL J. GUIGUET	13.08.2021					
SCALE 1:50						
PARTSSEMBLY NAME			DRAWING DESCRIPTION		DRAWING NO	
			AZ- RAMP-PRIME 10-10 FIX-L		---	

AZ MACHINERY - SLU, Matériels d'Élévation et Manutention
 13 rue de la scierie - 66340 PALAÏ DE CERDAGNÈS - France
 Téléphone : +33 (0) 3 77 46 505 - contact@az-machinery.com - www.az-machinery.com
 Site : S24 654 958 000 TVA - TVA : FR02 824 654 958 - N° FORET : FRAD 824 654 958

3
0

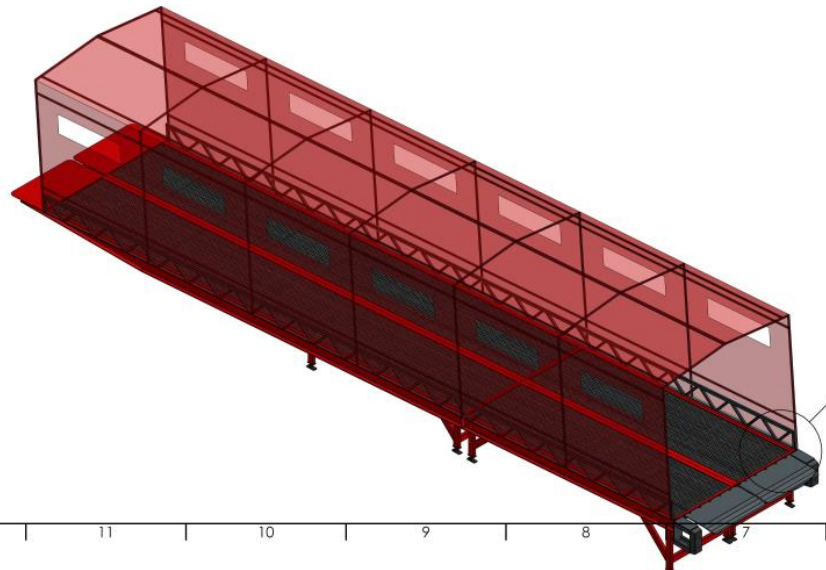
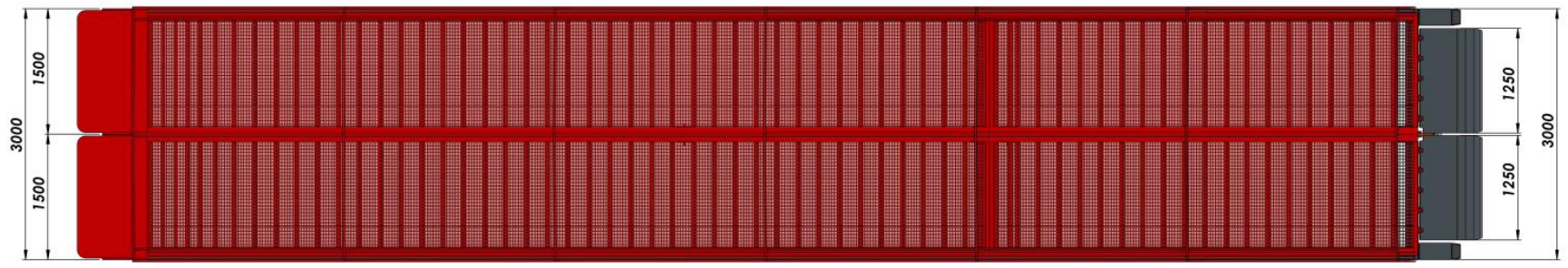
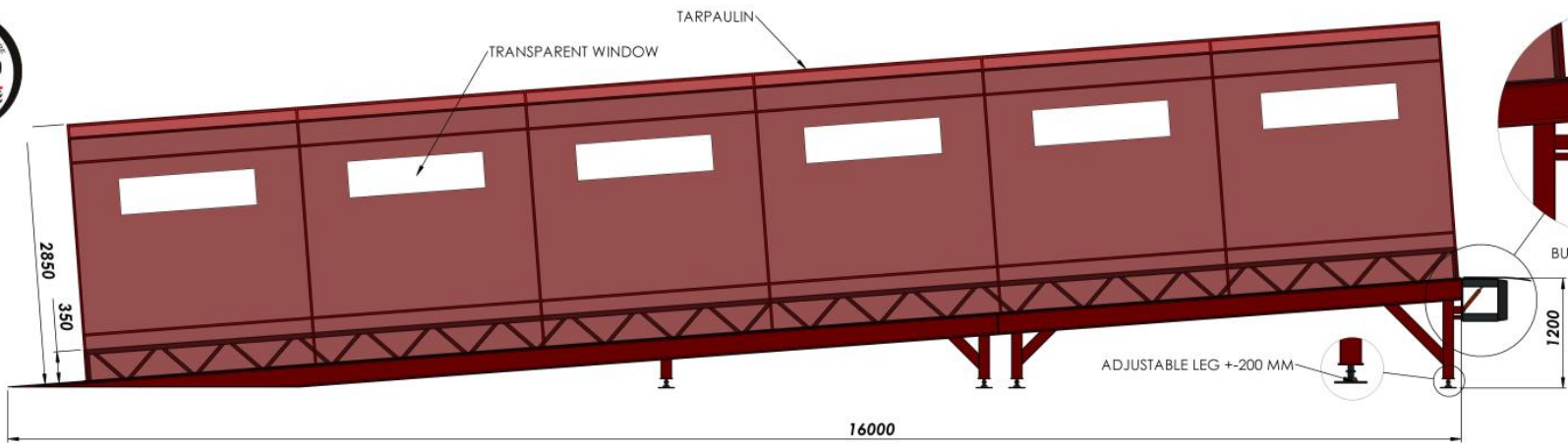

CAPACITY: 16000 KG DYNAMIC

NAME - SURNAME	DATE	SIGN	QUANTITY	MASS (KG)	MATERIAL	PAGE NR
DRAWN BY H. CANSEVER	27.03.2022		---			1/1
CONTROL A. HEPBILDI	27.03.2022					
APPROVAL S. ENTZMANN	27.03.2022					
SCALE 1:100						
PARTASSEMBLY NAME	DRAWING DESCRIPTION		DRAWING NO.			
	#SK.G2		---			



AZ MACHINERY - SLU, Matériels d'Élévation et Maintenance
 13 rue de la source - 46 340 PULVILLI DE CÉREBIANCO - France
 Téléphone : +33 (0) 27 48 500 - contact@az-machinery.com - www.az-machinery.com
 Site : 824 654 958 000 FR - TVA : FR02 824 654 958 - N° EORI : FR02 824 654 958

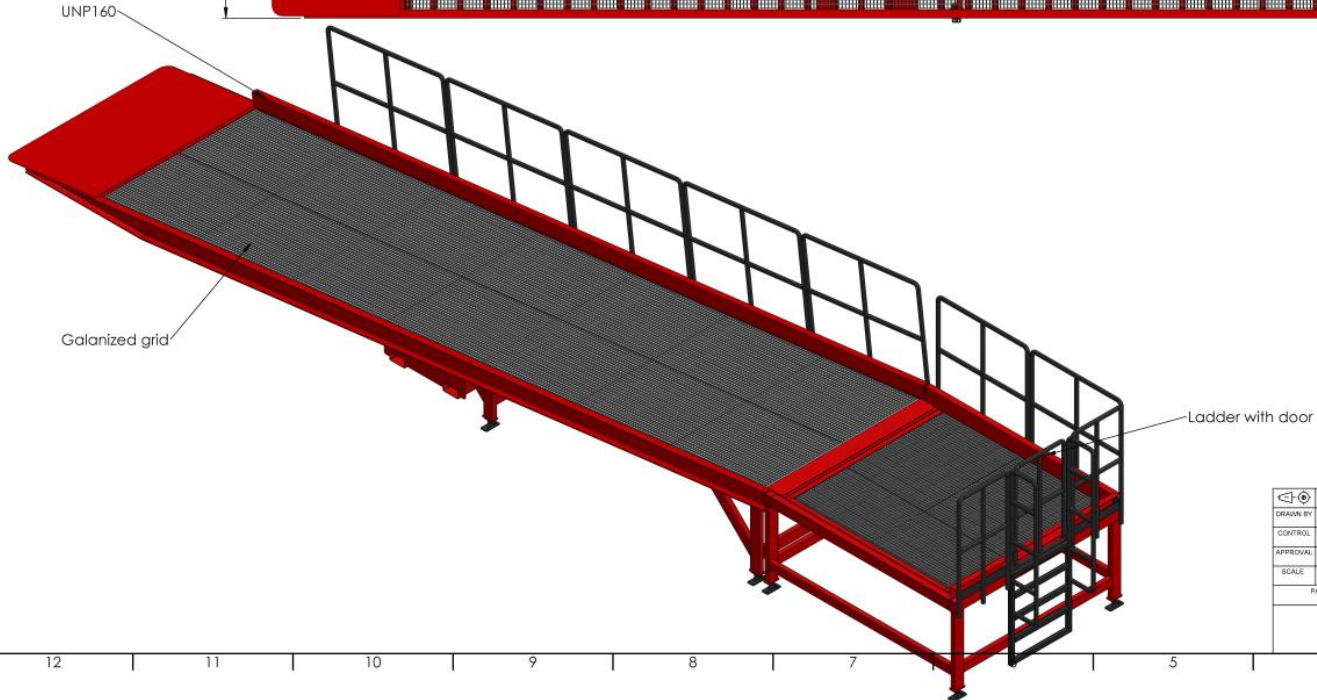
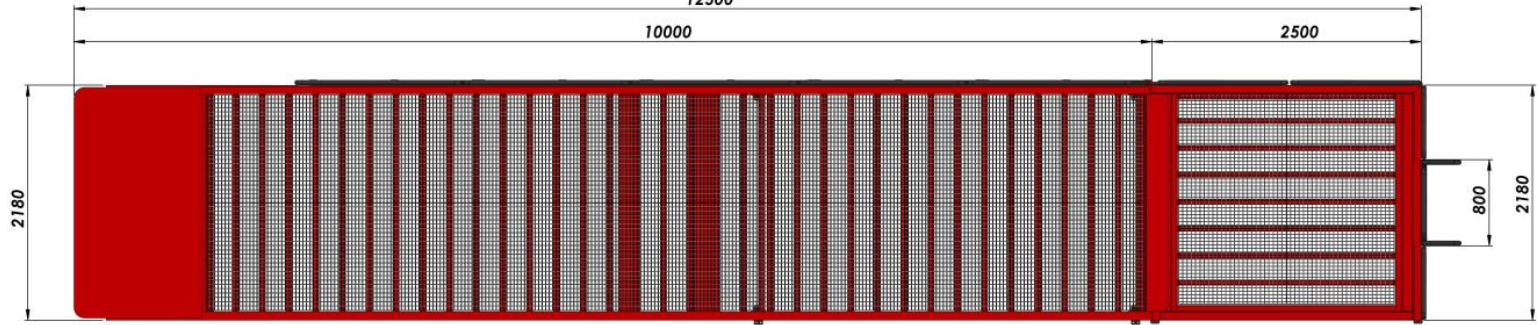
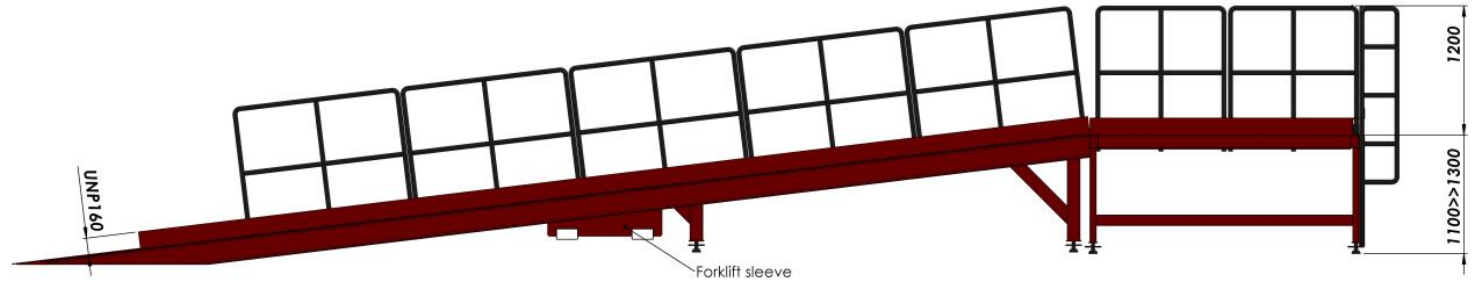

NAME - SURNAME	DATE	SIGN	QUANTITY	MASS (KG)	MATERIAL	PAGE/NT
DRAWN BY: H. CANSEVER	21.05.2022		---			1/1
CONTROL: A. HEPBILDI	21.05.2022					
APPROVAL: S. ENTZMANN	21.05.2022					
SCALE: 1:50						
PART/ASSEMBLY NAME			DRAWING DESCRIPTION		DRAWING NO.	
			#LJ25		---	



AZ MACHINERY - SLU, Matériels d'Élévation et Manutention
 13 rue de la source - 16 540 PÉLASSI DE CÉBERNORD - France
 Téléphone : +33 (0) 37 48 500 - contact@az-machinery.com - www.az-machinery.com
 Site : 824 654 958 000 FR - TVA : FR02 824 654 958 - N° EORI : FR02 824 654 958

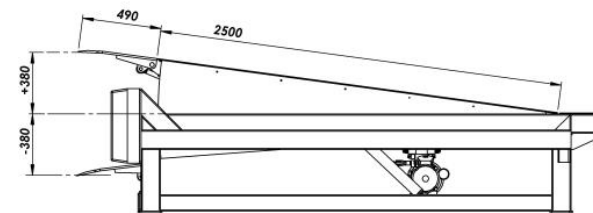
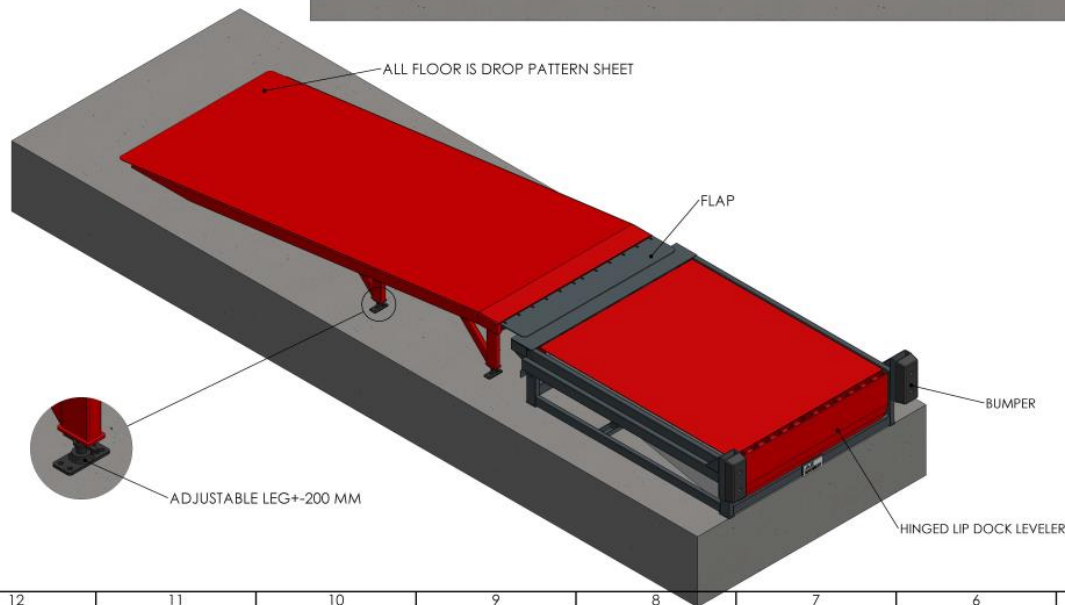
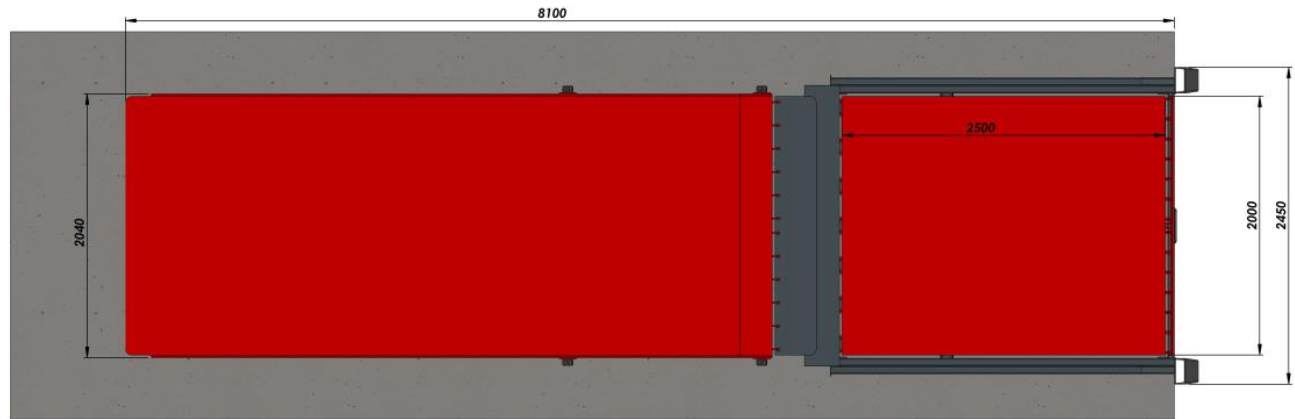
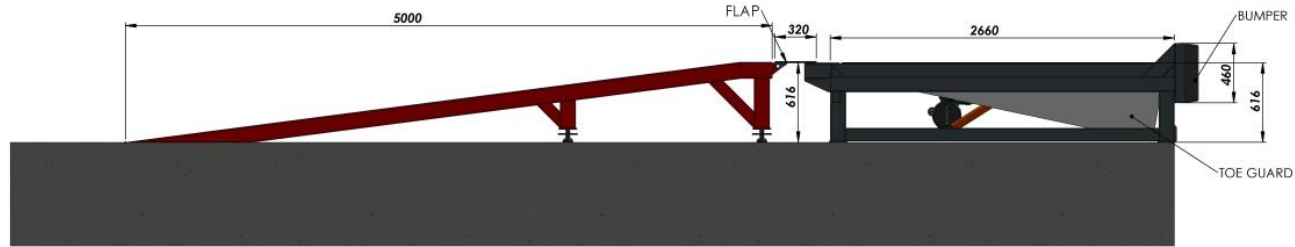

HINGED LIP DOCK LEVELER WORKING RANGE

CAPACITY: 10000 KG

NAME - SURNAME	DATE	SIGN	QUANTITY	MASS (KG)	MATERIAL	PAGE NR
DRAWN BY: H. CANSEVER	15.05.2022		---			1/1
CONTROL: A. HEPBILDI	15.05.2022					
APPROVAL: S. PERRIN	15.05.2022					
SCALE: 1:50						
PART/ASSEMBLY NAME			DRAWING DESCRIPTION		DRAWING NO.	
			£2205S02			



AZ MACHINERY - SLU, Matériels d'Élévation et Manutention
 13 rue de la source - 46 540 PALLAS DE CEEBAKINS - France
 Téléphone : +33 (0) 37 48 500 - contact@az-machinery.com - www.az-machinery.com
 Site : 824 654 958 000 FR - TVA : FR02 824 654 958 - 3^e EORL - FRAD 824 654 958

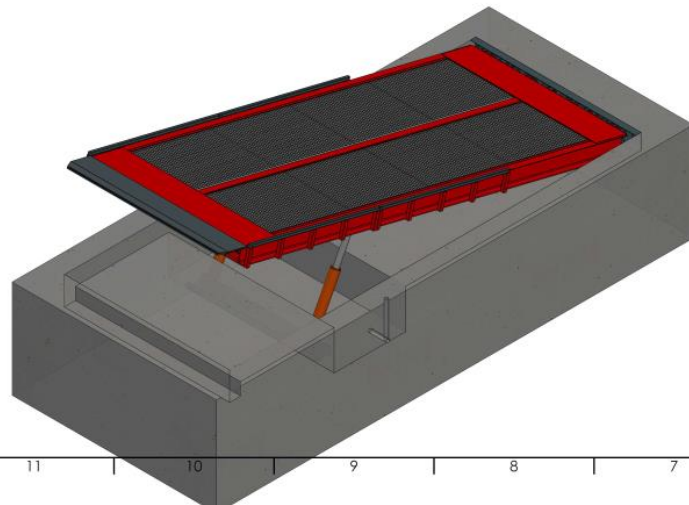
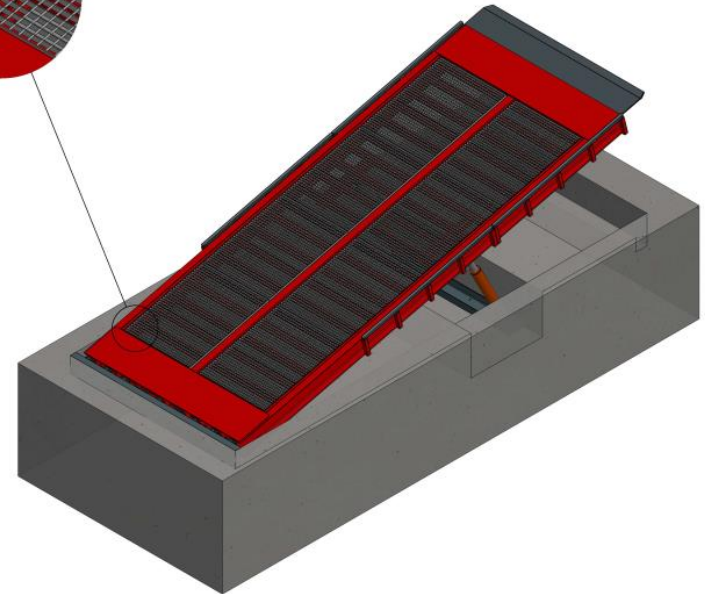
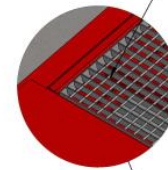
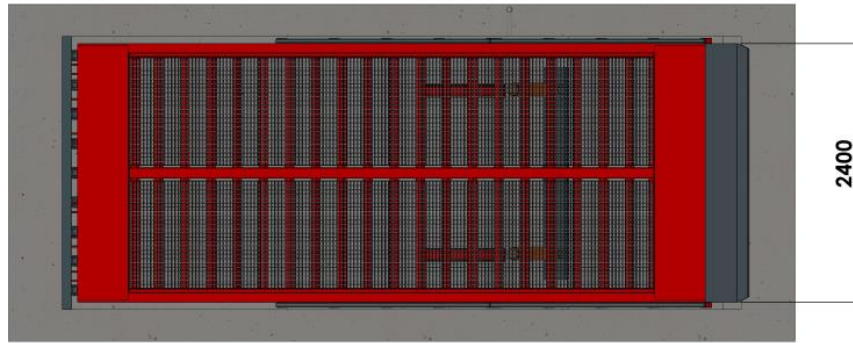
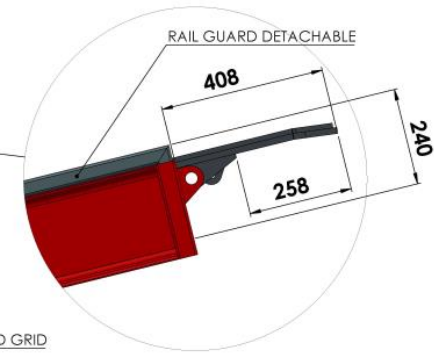
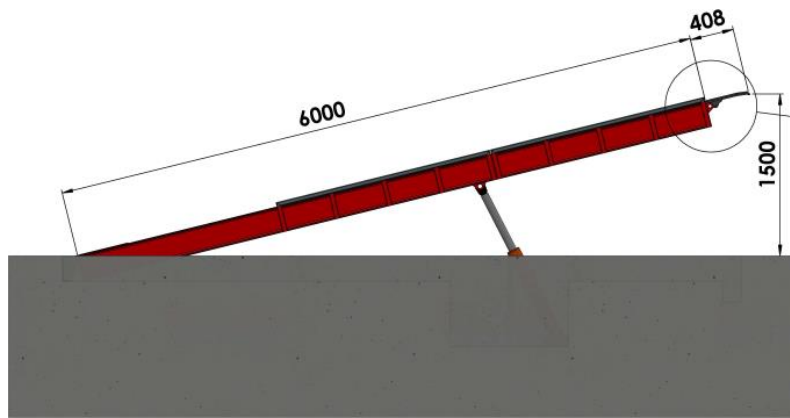

NAME - SURNAME	DATE	SIGN	QUANTITY	MASS (KG)	MATERIAL	PAGE/NT
DRAWN BY: H. CANSEVER	30.11.2021		---			1/1
CONTROL: A. HEPBILDI	30.11.2021					
APPROVAL: S. ENTZMANN	30.11.2021					
SCALE: 1:50						
PART/ASSEMBLY NAME			DRAWING DESCRIPTION		DRAWING NO.	
			#DSM85		---	



AZ MACHINERY - SLU, Matériels d'Élévation et Maintenance
 13 rue de la scierie - 86 540 PALLATI DE CEEBACONS - France
 Téléphone : +33 (0) 27 48 500 - contact@az-machinery.com - www.az-machinery.com
 Site : 824 654 958 000 FR - TVA : FR02 824 654 958 - 3° E0081 - REAO 824 654 958

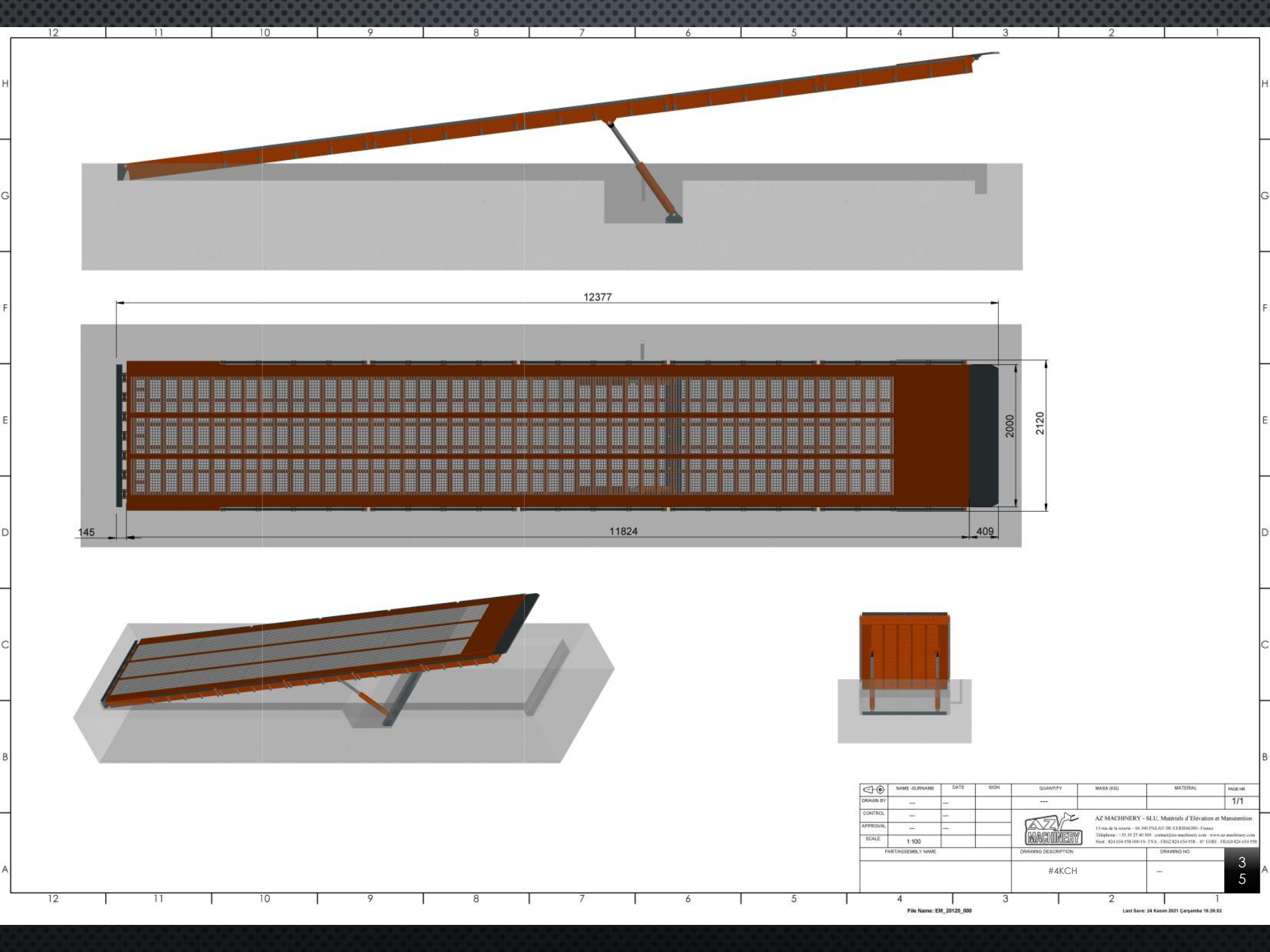

NAME	GLRNAME	DATE	SIGN	QUANTITY	MASS (KG)	MATERIAL	PAGE NR
DRAWN BY	---	---	---	---	---	---	1/1
CONTROL	---	---	---	---	---	---	---
APPROVAL	---	---	---	---	---	---	---
SCALE	1:100	---	---	---	---	---	---
PART/ASSEMBLY NAME				DRAWING DESCRIPTION		DRAWING NO.	
				#4KCH		---	



AZ MACHINERY - SLU, Matériels d'Élévation et Maintenance
 13 rue de la source - 86 540 PALLATI DE CEEBAKENS - France
 Téléphone : +33 (0) 27 48 500 - contact@az-machinery.com - www.az-machinery.com
 Site : 824 654 958 000 FR - TVA : FR02 824 654 958 - N° EORI : FR02 824 654 958

3
5



DRAWINGS

Rampes mobiles

Rampes fixes

Plateformes logistiques

Réhausse

Tables de quai mobiles

Tables de quai fixes

Passerelles

Rampes pour conteneurs

Niveleurs

Autres confections

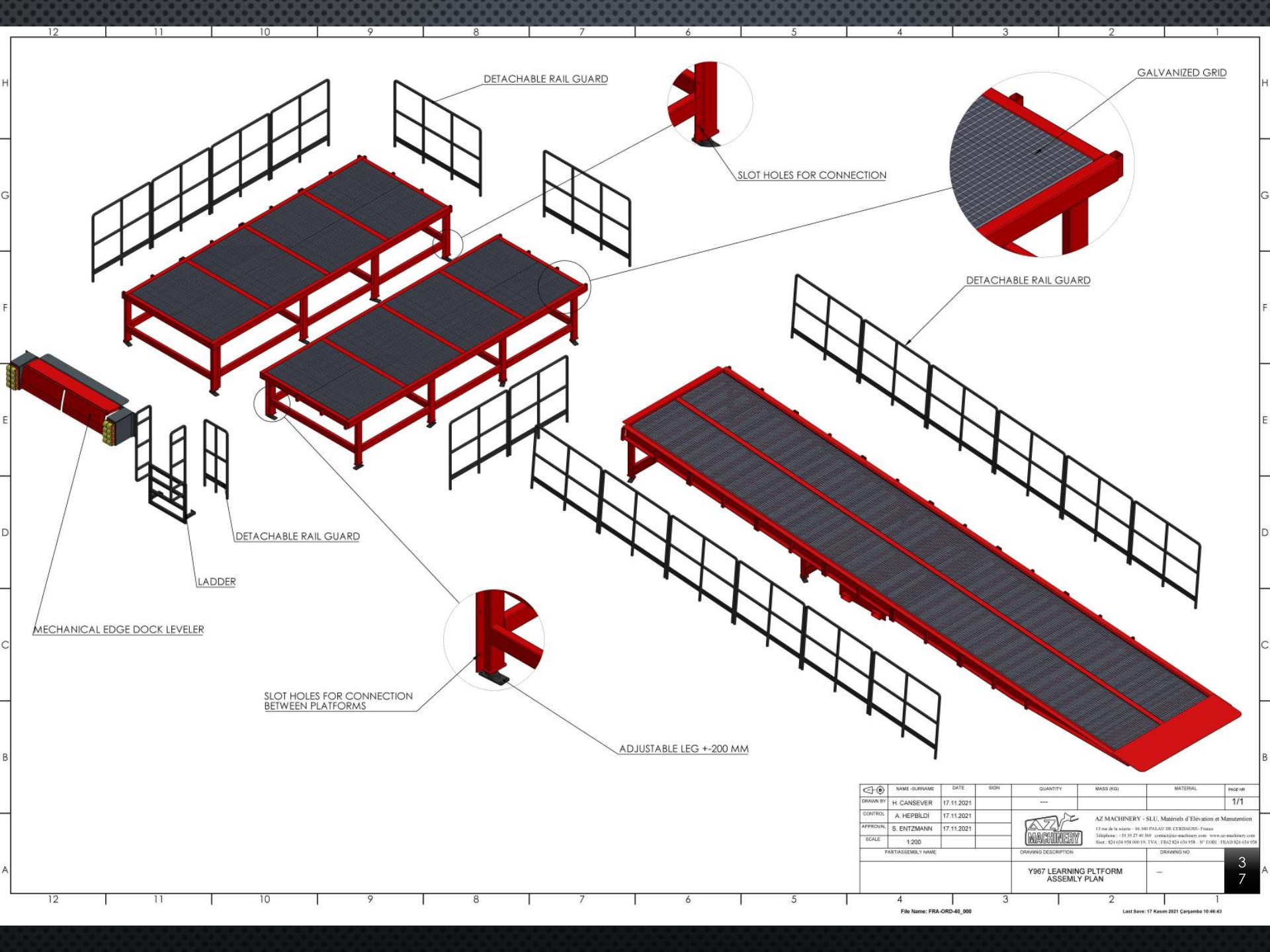

NAME - SURNAME	DATE	SIGN	QUANTITY	MASS (KG)	MATERIAL	PAGE NR
DRAWN BY: H. CANSEVER	17.11.2021		---			1/1
CONTROL: A. HEPBILDI	17.11.2021					
APPROVAL: S. ENTZMANN	17.11.2021					
SCALE: 1:200						
PARTS/ASSEMBLY NAME			DRAWING DESCRIPTION			DRAWING NO.
			Y967 LEARNING PLTFORM ASSEMBLY PLAN			---

AZ MACHINERY - SLU, Matériels d'Élévation et Maintenance
 13 rue de la machine - 46 340 PLAZAT DE CÉREACHRE - France
 Téléphone : +33 (0) 27 46 500 - contact@az-machinery.com - www.az-machinery.com
 Site : 424 654 958 666 FR - TVA : FR02 824 654 958 - 3^e EDI001 - FR03 824 654 958

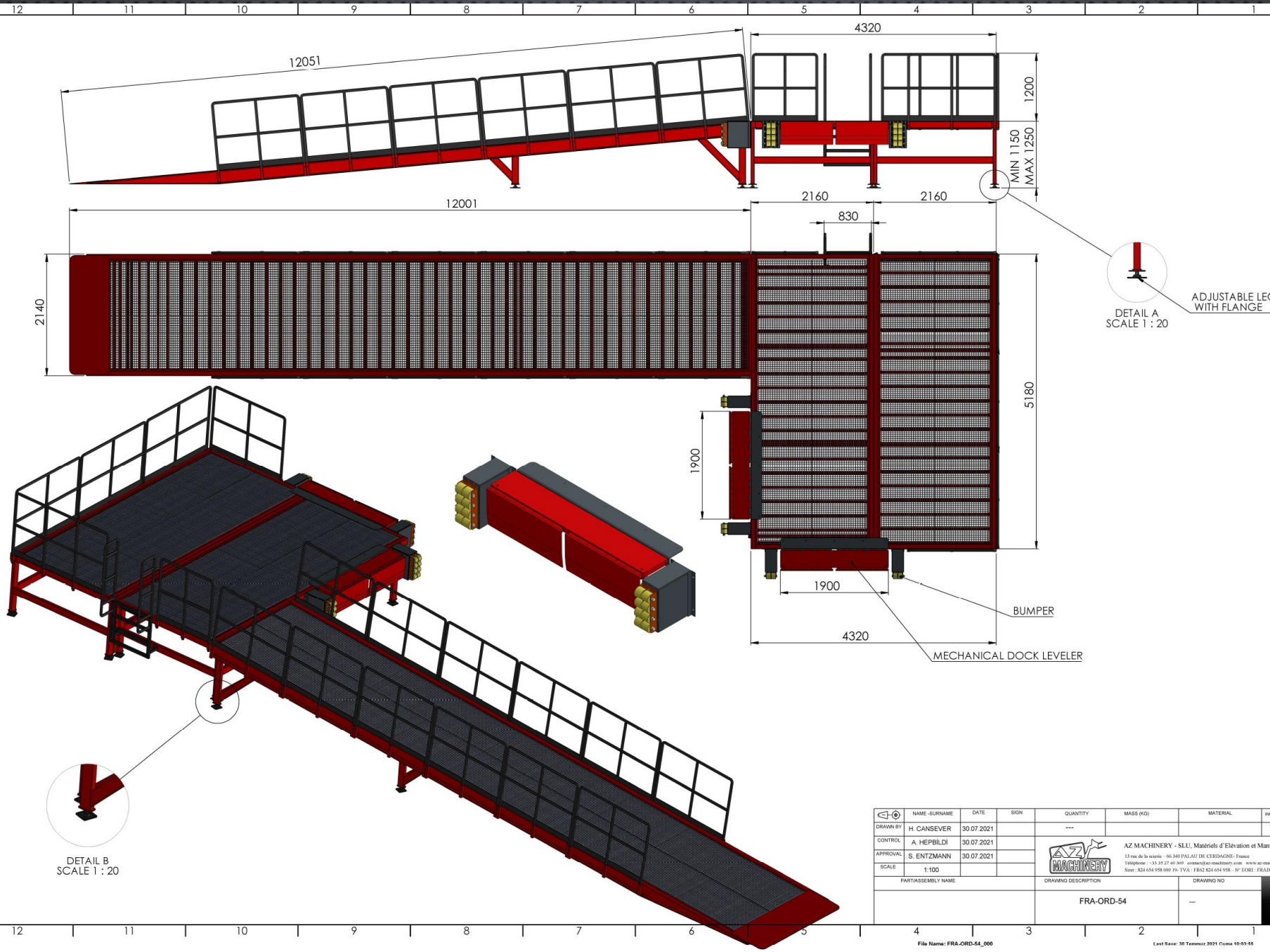

NAME-SURNAME	DATE	SIGN	QUANTITY	MASS (KG)	MATERIAL	PAGE NR
DRAWN BY H. CANSEVER	30.07.2021		---			1/1
CONTROL A. HEPBILDI	30.07.2021					
APPROVAL S. ENTZMANN	30.07.2021					
SCALE 1:100						
PARTSSEMBLY NAME		DRAWING DESCRIPTION		DRAWING NO		
		FRA-ORD-54		---		

AZ MACHINERY - SLU, Matériels d'Élévation et Manutention
 13 rue de la scierie - 66340 PALAISE DE CERDAGNE - France
 Téléphone : +33 (0) 37 37 40 500 - contact@az-machinery.com - www.az-machinery.com
 Site : S24 654 958 000 FR - TVA : FR02 824 654 958 - N° EORI : FR02 824 654 958

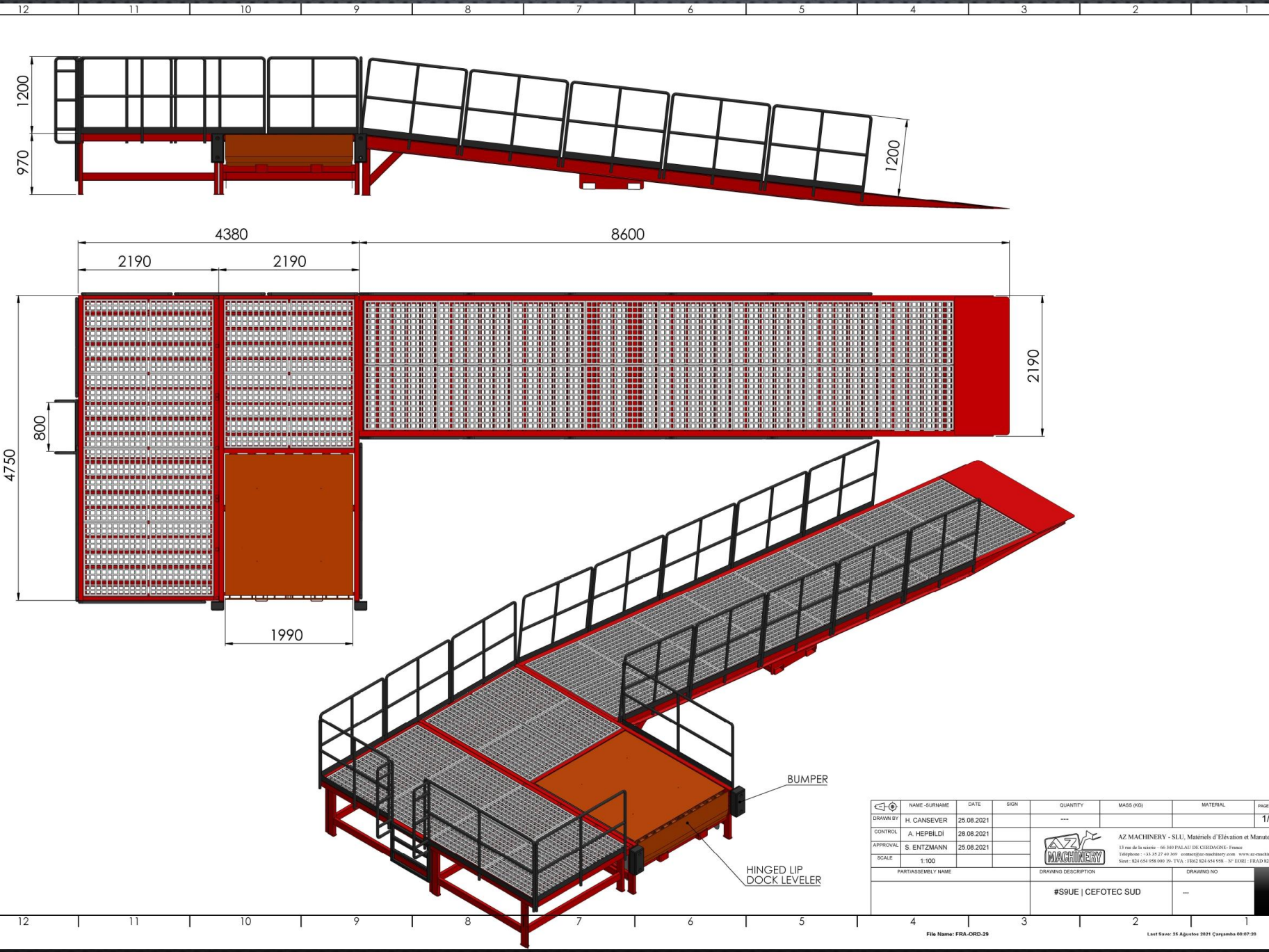

NAME-SURNAME	DATE	SIGN	QUANTITY	MASS (KG)	MATERIAL	PAGE NR
H. CANSEVER	25.08.2021		---			1/1
A. HEPBILDI	28.08.2021					
S. ENTZMANN	25.08.2021					
SCALE	1:100					
PARTASSEMBLY NAME	DRAWING DESCRIPTION		DRAWING NO			
	#SSUE CEFOTEC SUD		---			



AZ MACHINERY - SLU, Matériels d'Élévation et Manutention
 13 rue de la scierie - 06340 PALAISEAU DE CERDASNIEN - France
 Téléphone : +33 (0) 47 48 500 - contact@az-machinery.com - www.az-machinery.com
 Site : 824 654 958 000 TVA - TVA : FR02 824 654 958 - N° EORI : FRAD 824 654 958

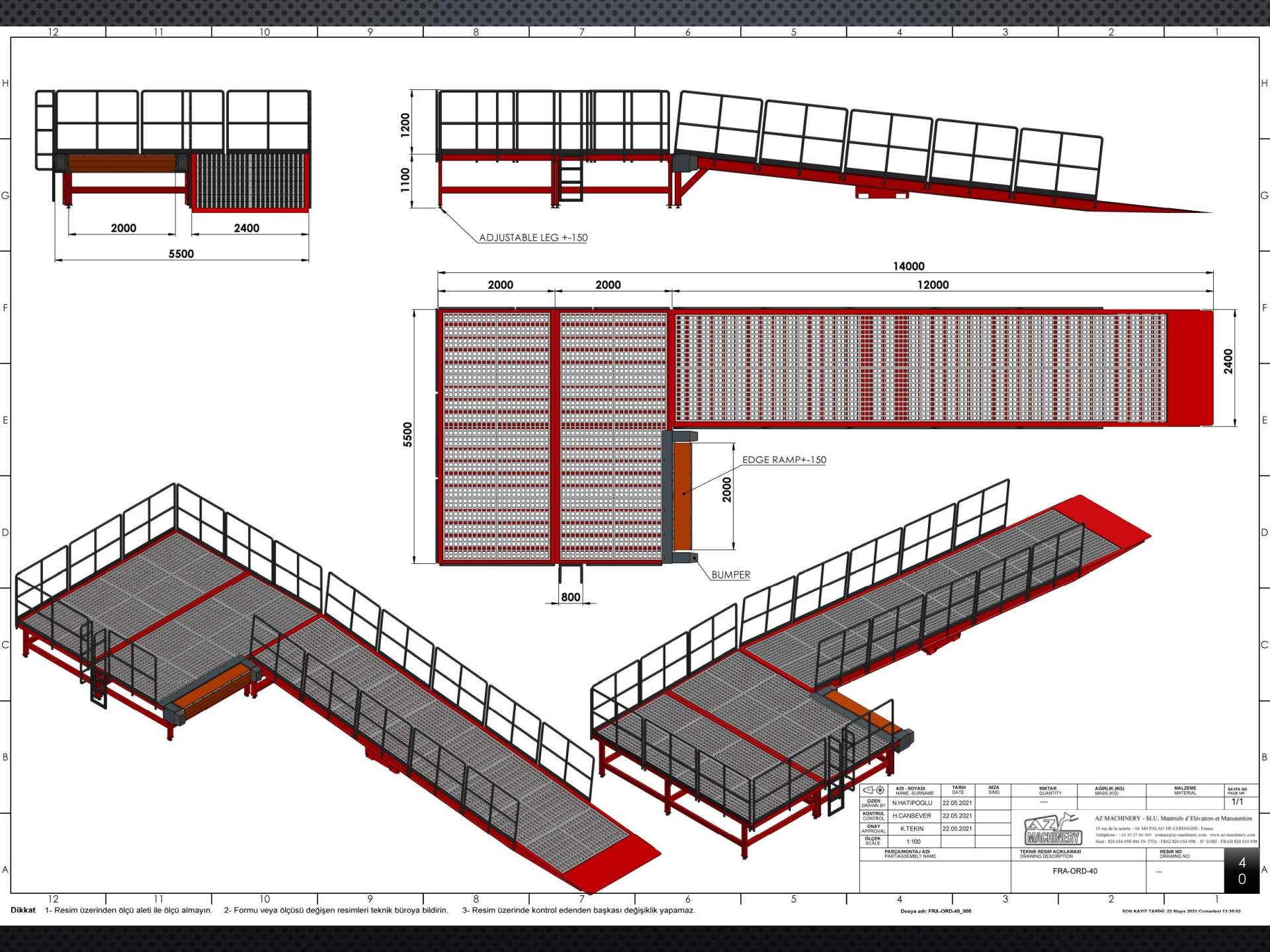

ADI - BOYADI NAME - SURNAME	TARİH DATE	İMZA SIGN	MİKTAR QUANTITY	AĞIRLIK (KG) MASS (kg)	MALZEME MATERIAL	SAYFA NO PAGE NO
ÖZGEN DRAWN BY	N.HATİPOĞLU 22.05.2021		---			1/1
KONTROL CONTROL	H.CANSEVER 22.05.2021					
ONAY APPROVAL	K.TEKİN 22.05.2021					
ÖLÇEK SCALE	1:100					
PARÇANIN MONTAJ ADI PART/ASSEMBLY NAME			TEKNİK RESİM AÇIKLAMASI DRAWING DESCRIPTION			RESİM NO DRAWING NO
			FRA-ORD-40			4 0

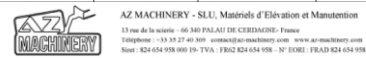

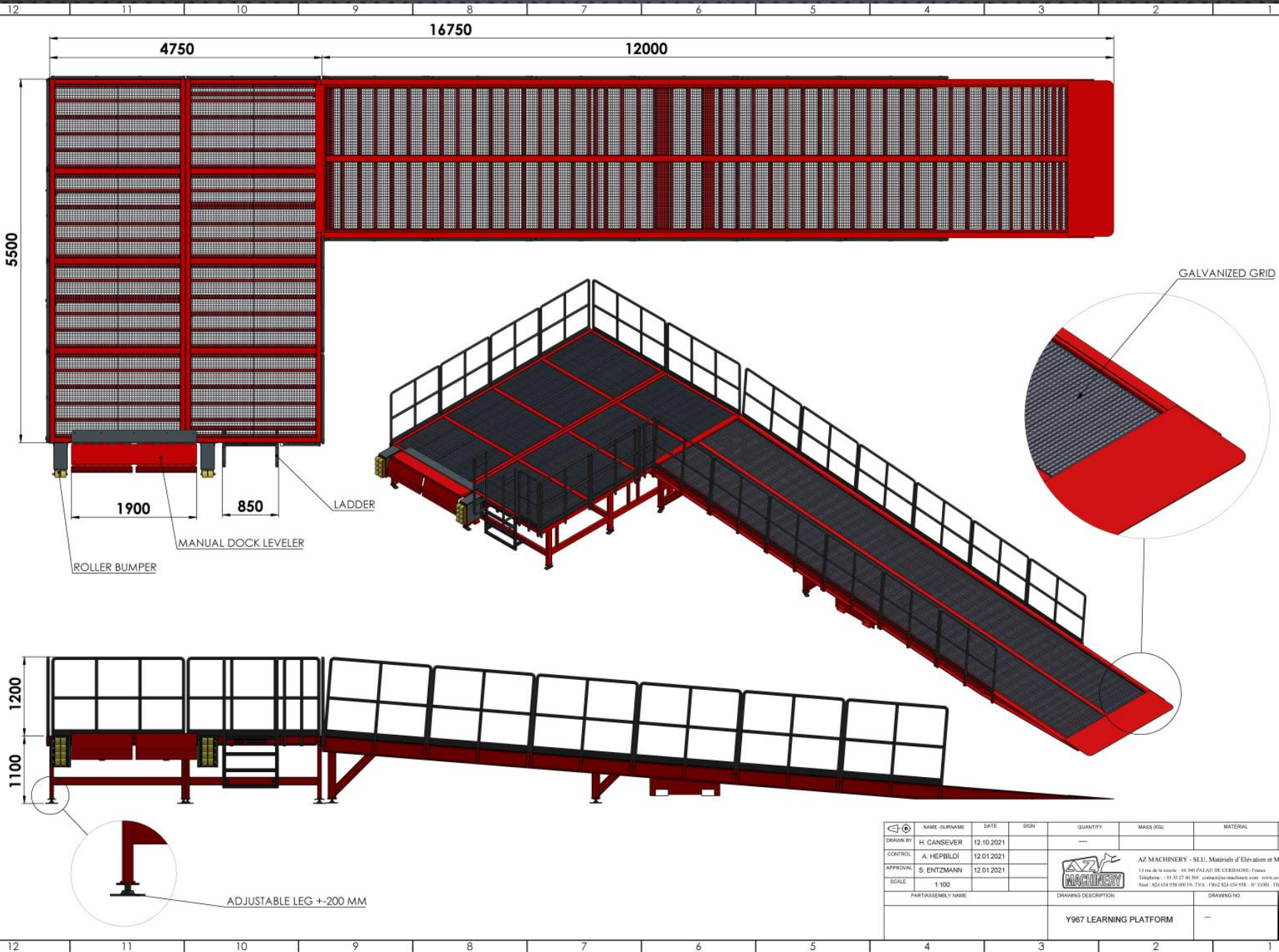

NAME - SURNAME	DATE	SIGN	QUANTITY	MASS (KG)	MATERIAL	PAGE NR
DRAWN BY: H. CANSEVER	12.10.2021		---			1/1
CONTROL: A. HEPBILDI	12.01.2021					
APPROVAL: S. ENTZMANN	12.01.2021					
SCALE: 1:100						
PART/ASSEMBLY NAME			DRAWING DESCRIPTION		DRAWING NO.	
			Y967 LEARNING PLATFORM		---	

AZ MACHINERY
 AZ MACHINERY - SLU, Matériels d'Élévation et Maintenance
 13 rue de la source - 46 340 PALLATI DE CERDACHEN - France
 Téléphone : +33 (0) 27 46 340 - contact@az-machinery.com - www.az-machinery.com
 Site : 424 654 958 660 FR - TVA : FR02 424 654 958 - N° EORI : FR02 424 654 958

12 11 10 9 8 7 6 5 4 3 2 1

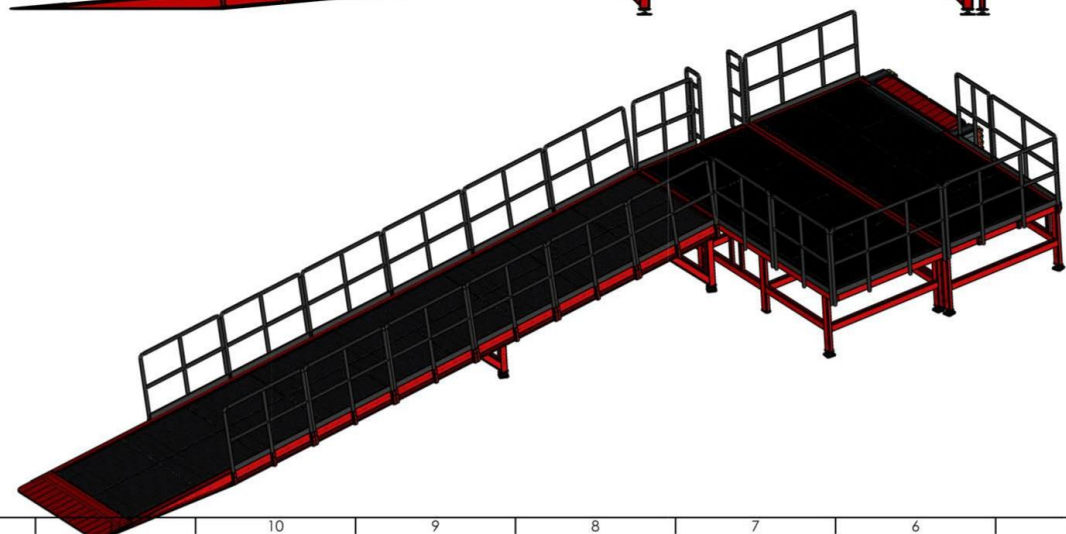
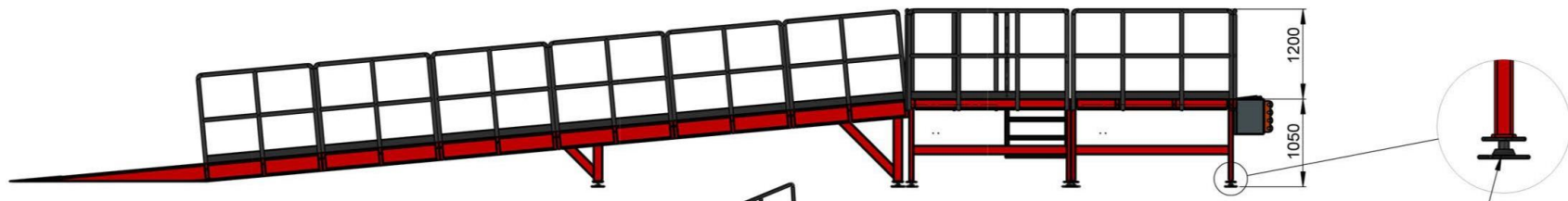
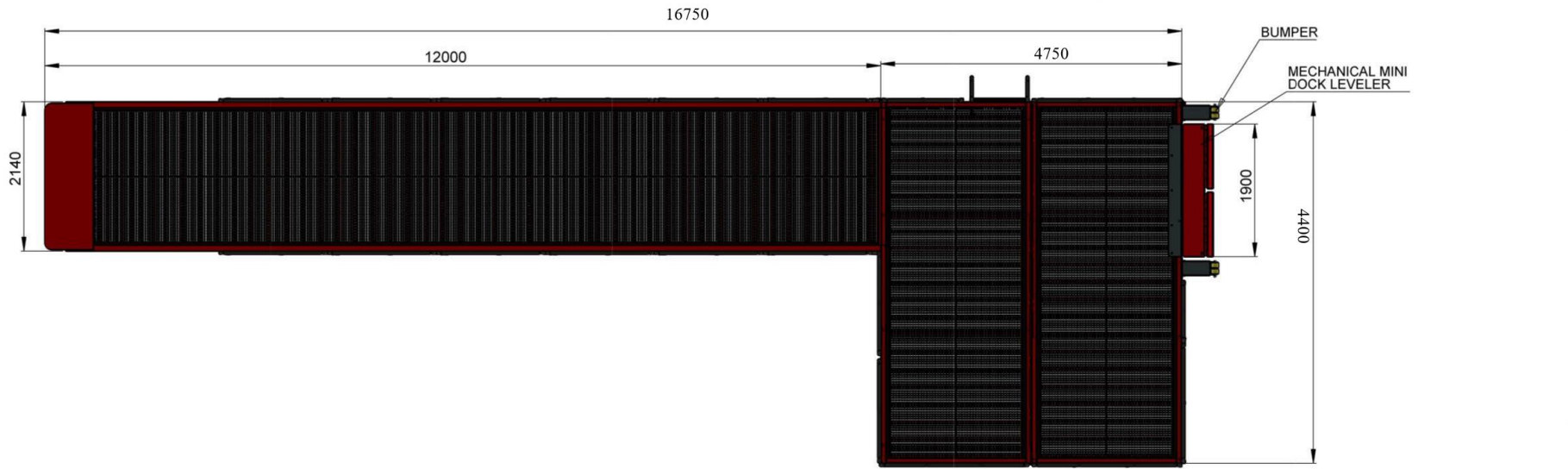

NAME - SURNAME	DATE	SIGN	QUANTITY	MASS (KG)	MATERIAL	PAGE NR
DRAWN BY H. CANSEVER	04.09.2021		---			1/1
CONTROL A. HEPBILDI	04.09.2021					
APPROVAL S. ENTZMANN	04.09.2021					
SCALE 1:100						
PART/ASSEMBLY NAME	DRAWING DESCRIPTION		DRAWING NO.			
	#6F56		---			

AZ MACHINERY - SLU, Matériels d'Élévation et Manutention
 13 rue de la source - 66340 PALAU DE CERDAGNE - France
 Téléphone : +33 (0) 3 27 49 349 - contact@az-machinery.com - www.az-machinery.com
 Site : 824 654 958 000 FR - TVA : FR02 824 654 958 - N° EORI : FR02 824 654 958

12 11 10 9 8 7 6 5 4 3 2 1

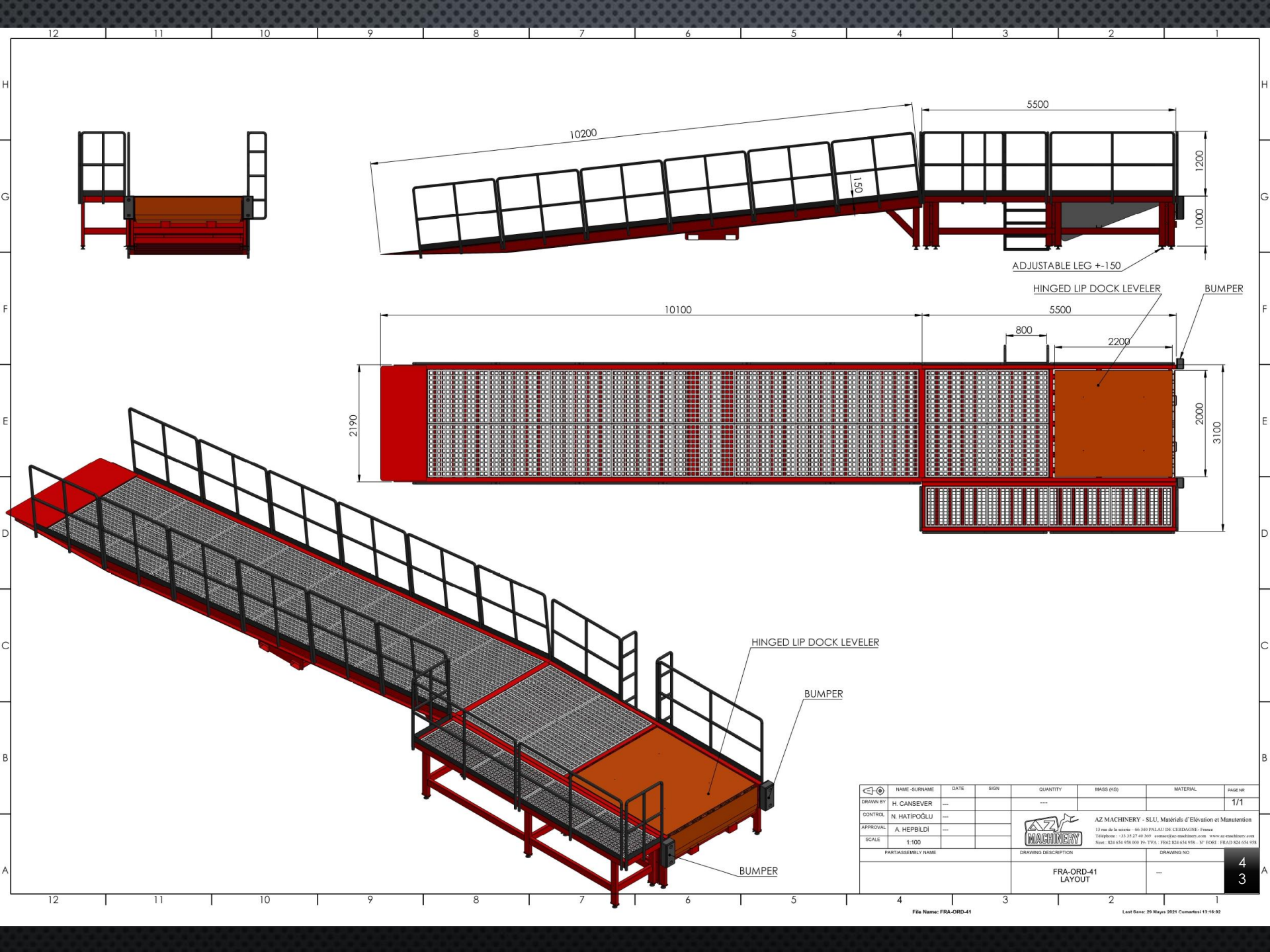

NAME-SURNAME	DATE	SIGN	QUANTITY	MASS (KG)	MATERIAL	PAGE NR
DRAWN BY: H. CANSEVER	---	---	---	---	---	1/1
CONTROL: N. HATİPOĞLU	---	---	---	---	---	---
APPROVAL: A. HEPBİLDİ	---	---	---	---	---	---
SCALE: 1:100	---	---	---	---	---	---
PART/ASSEMBLY NAME	DRAWING DESCRIPTION		DRAWING NO			
	FRA-ORD-41 LAYOUT		---			

AZ MACHINERY - SLU, Matériels d'Élévation et Manutention
 13 rue de la machine - 66 340 PALAIS DE CERDAS/ENNE - France
 Téléphone : +33 (0) 27 46 509 - contact@az-machinery.com - www.az-machinery.com
 Site : 824 654 958 000 FR - TVA : FR02 824 654 958 - N° EORI : FR02 824 654 958

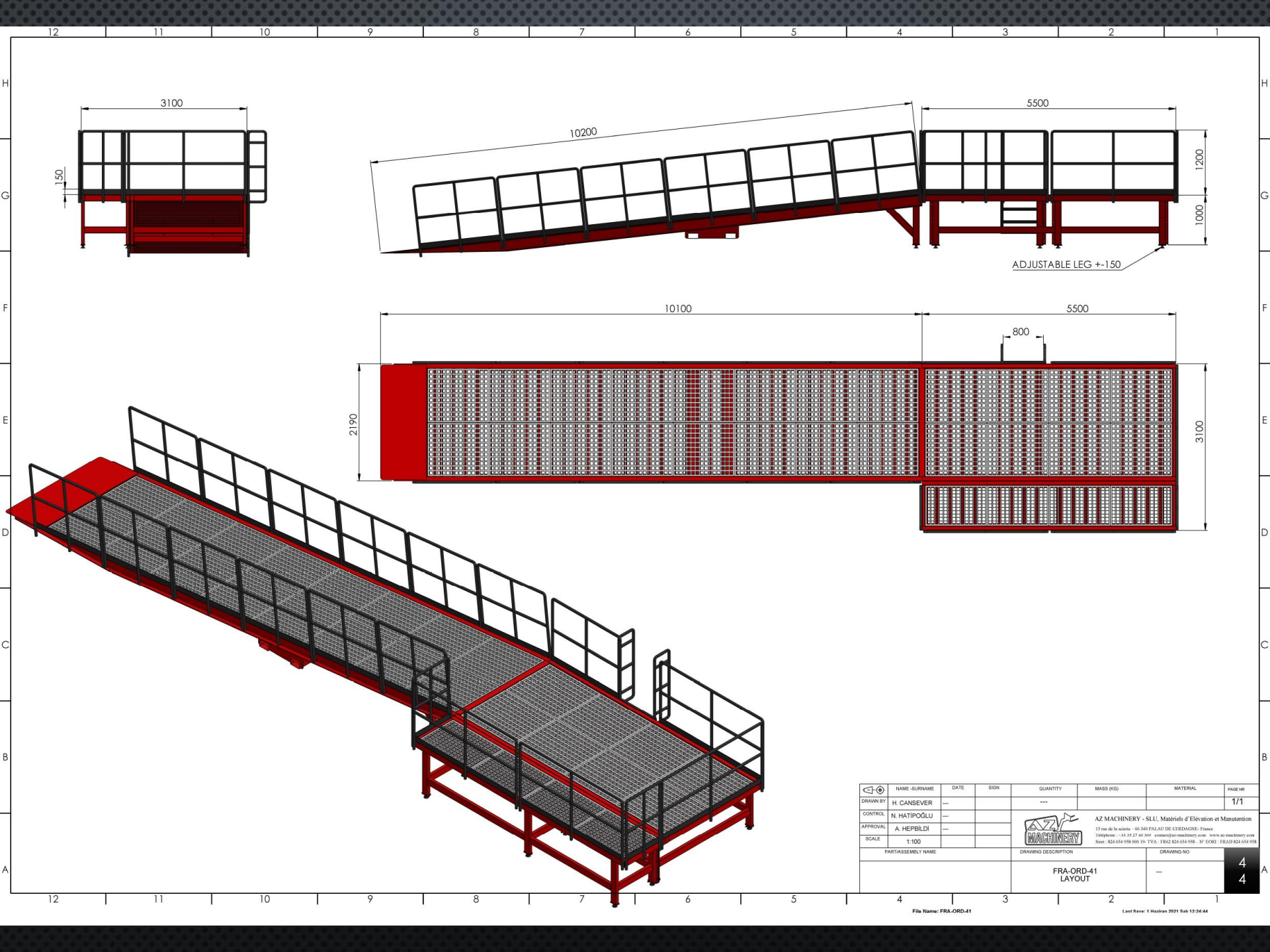

NAME - SURNAME	DATE	SIGN	QUANTITY	MASS (KG)	MATERIAL	PAGE NR
DRAWN BY H. CANSEVER	---	---	---			1/1
CONTROL N. HATİPOĞLU	---	---				
APPROVAL A. HEPBİLDİ	---	---				
SCALE 1:100						
PART/ASSEMBLY NAME	DRAWING DESCRIPTION		DRAWING NO			
	FRA-ORD-41 LAYOUT		---			



AZ MACHINERY - SLU, Matériels d'Élévation et Manutention
 13 rue de la scierie - 06340 PALAISEAU DE CERDASNIEN - France
 Téléphone : +33 (0) 47 48 500 - contact@az-machinery.com - www.az-machinery.com
 Site : S24 654 958 000 19 - TVA : FR02 824 654 958 - N° EORI : FRAD 824 654 958

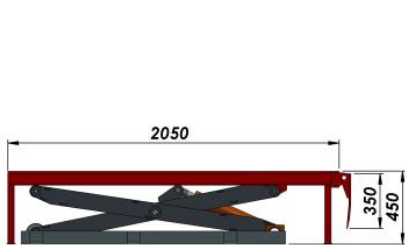
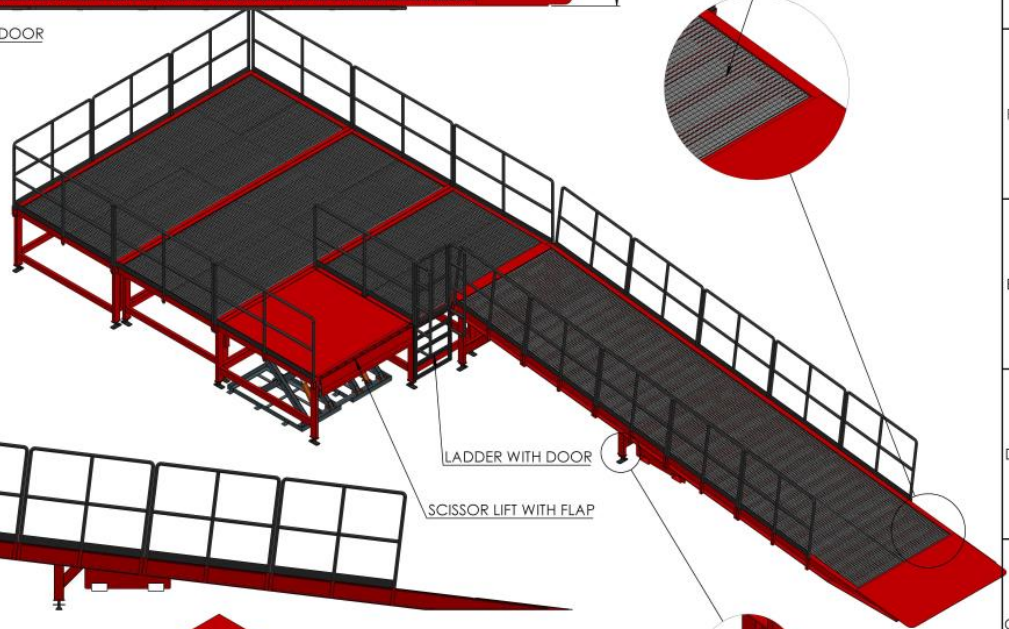
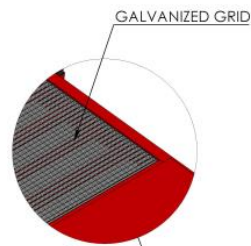
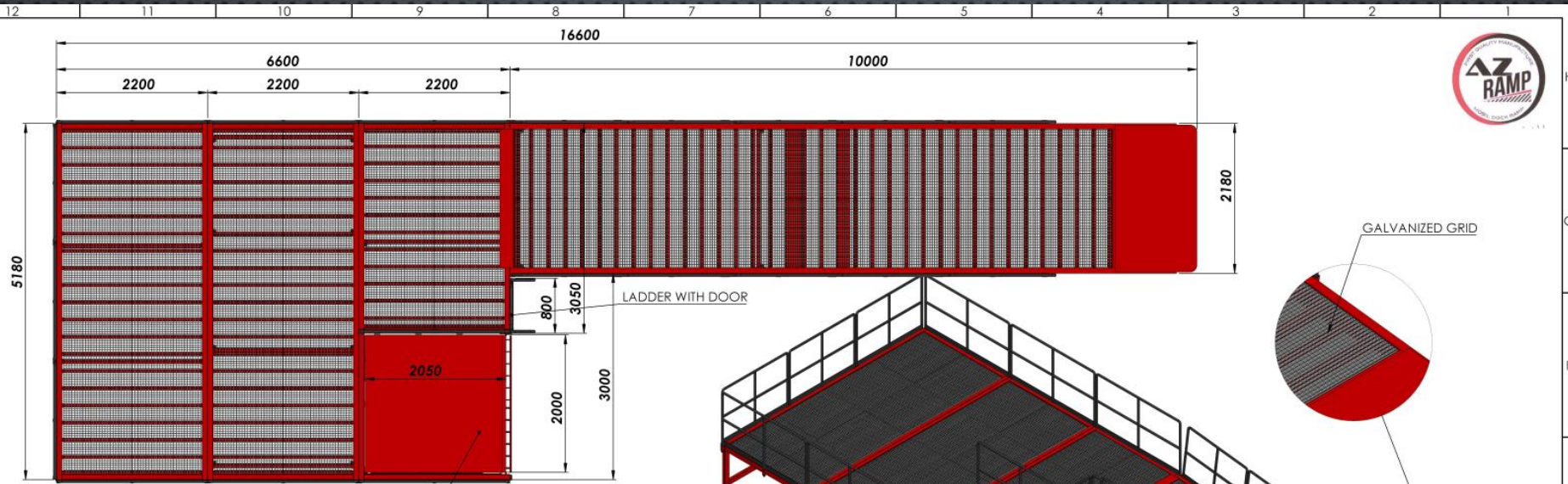

MINIMUM POSITION OF SCISSOR LIFT

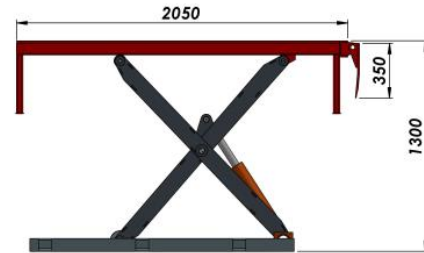

MAXIMUM POSITION OF SCISSOR LIFT

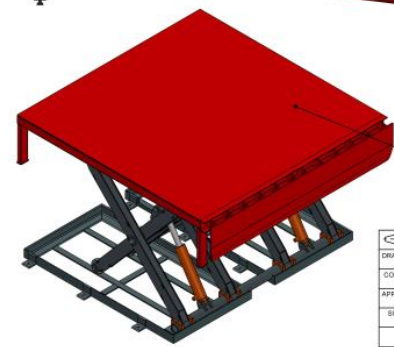

SCISSOR LIFT CAPACITY IS 8000 KG



NAME - SURNAME	DATE	SIGN	QUANTITY	MASS (KG)	MATERIAL	PAGE NR
DRAWN BY: H. CANSEVER	08.01.2022		---			1/1
CONTROL: A. HEPBILDI	08.01.2022					
APPROVAL: S. ENTZMANN	08.01.2022					
SCALE: 1:100						
PART/ASSEMBLY NAME	DRAWING DESCRIPTION:		DRAWING NO.			
	#CH02D-R1		---			



AZ MACHINERY - SLU, Matériels d'Élévation et Maintenance
 13 rue de la source - 66340 PALLAS DE CERDANNE - France
 Téléphone : +33 (0) 37 48 300 - Courriel: az-machinery.com - www.az-machinery.com
 Site : 824 654 958 (66) FR - TVA : FR02 824 654 958 - N° EORI : FR02 824 654 958

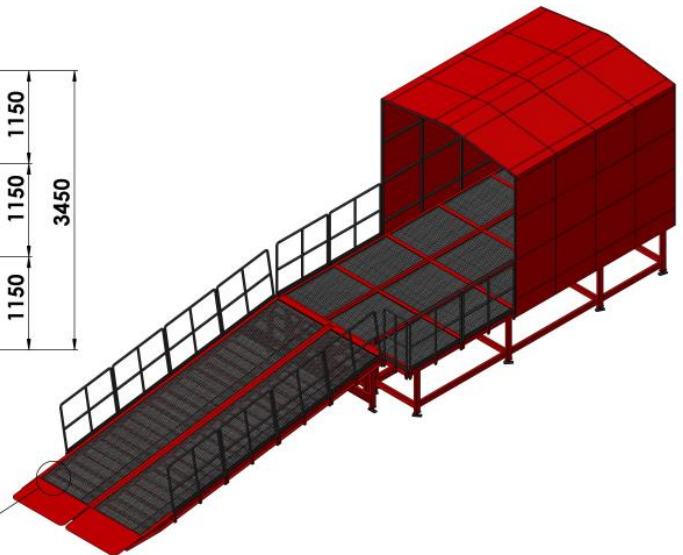
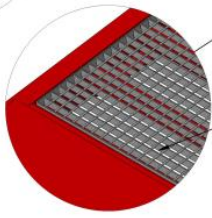
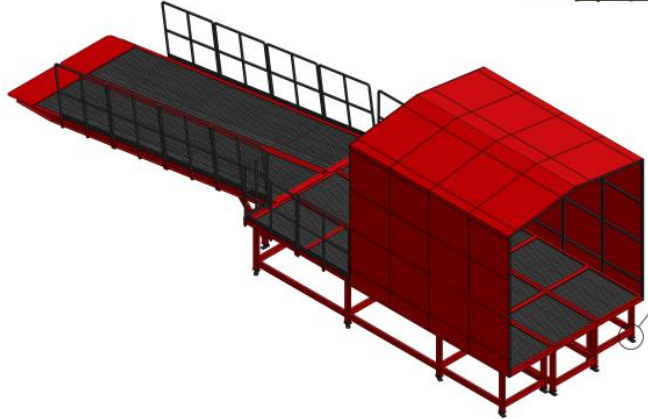
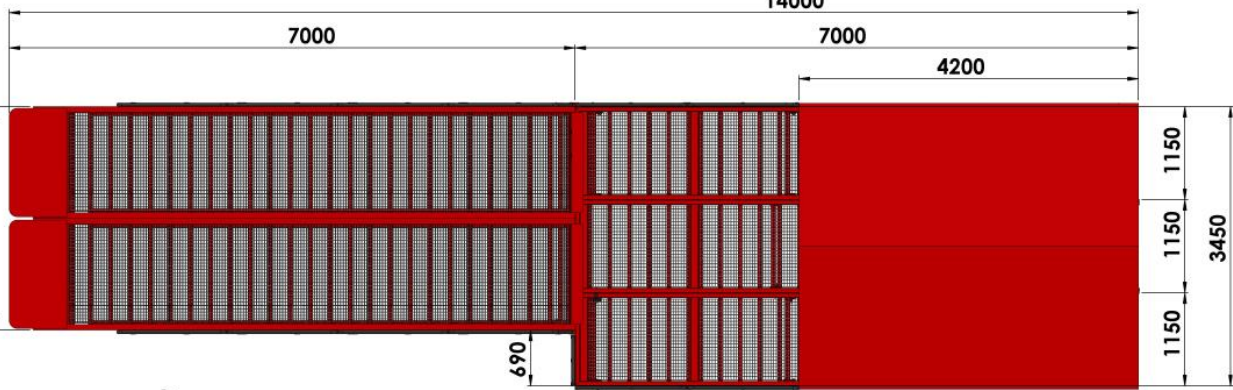
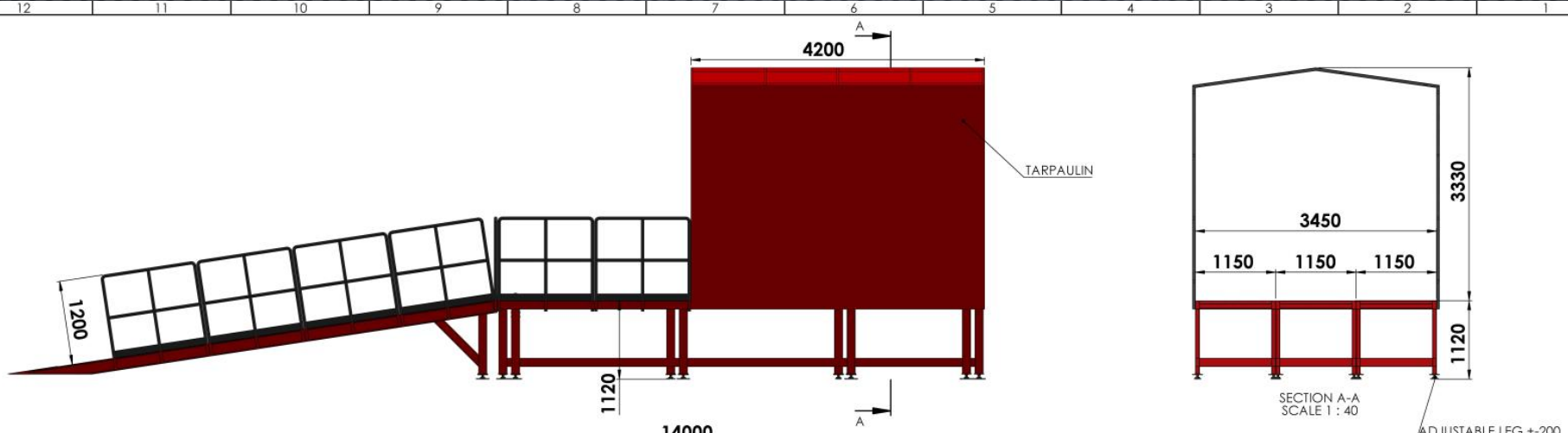

NAME - SURNAME	DATE	SIGN	QUANTITY	MASS (KG)	MATERIAL	PAGE/NT
DRAWN BY: H. CANSEVER	14.10.2021		---			1/1
CONTROL: A. HEPBILDI	14.10.2021					
APPROVAL: S. ENTZMANN	14.10.2021					
SCALE: 1:100						
PART/ASSEMBLY NAME	DRAWING DESCRIPTION:		DRAWING NO.			
	#E2CD		---			



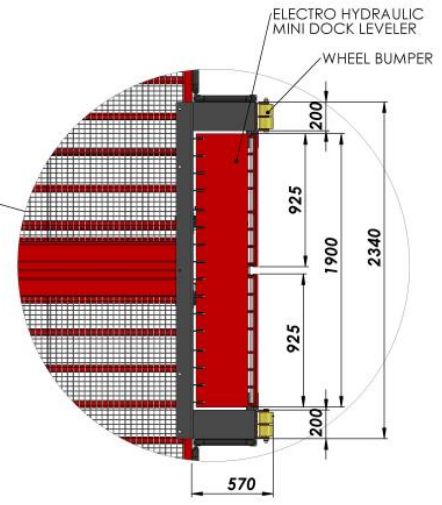
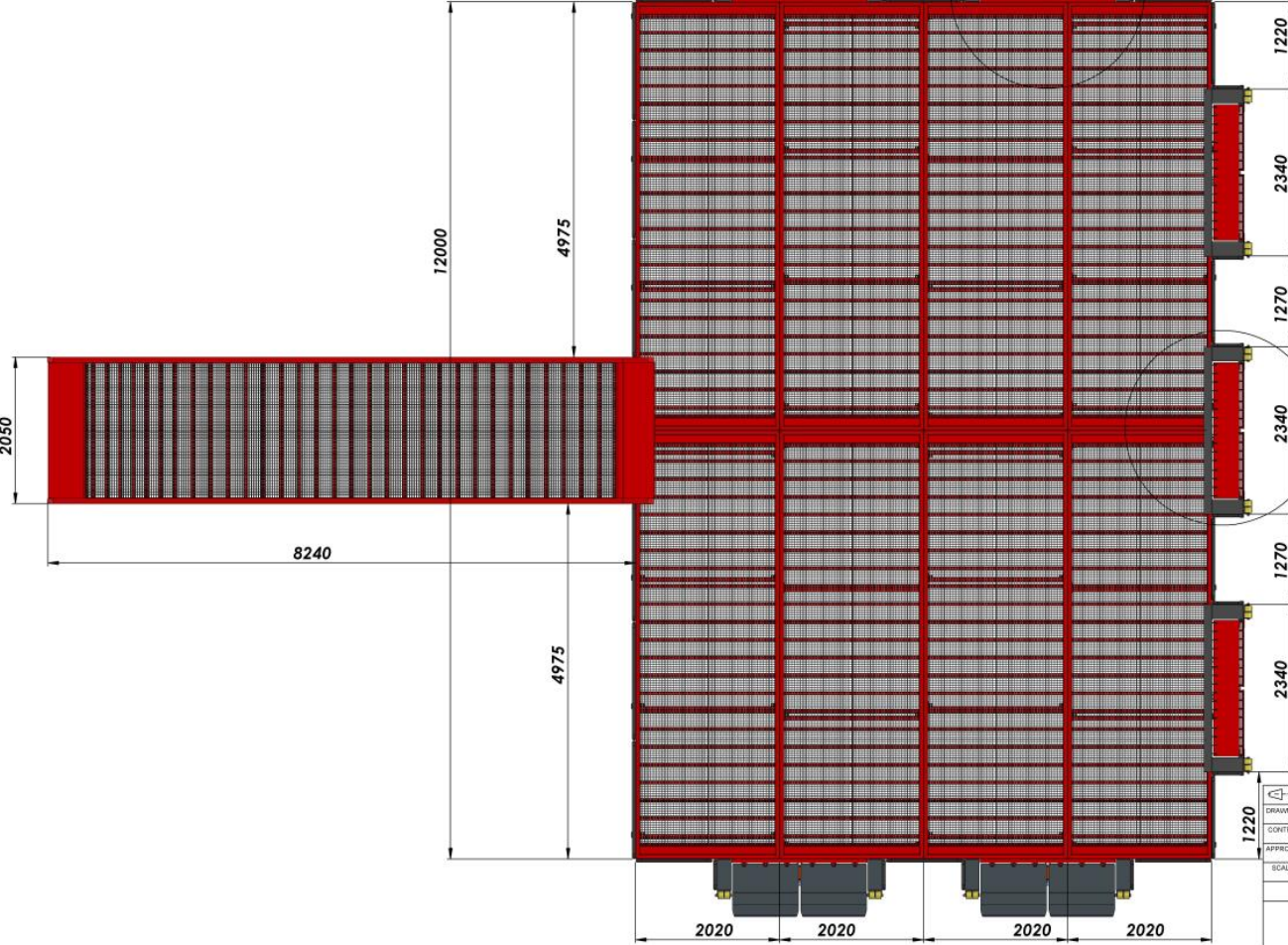
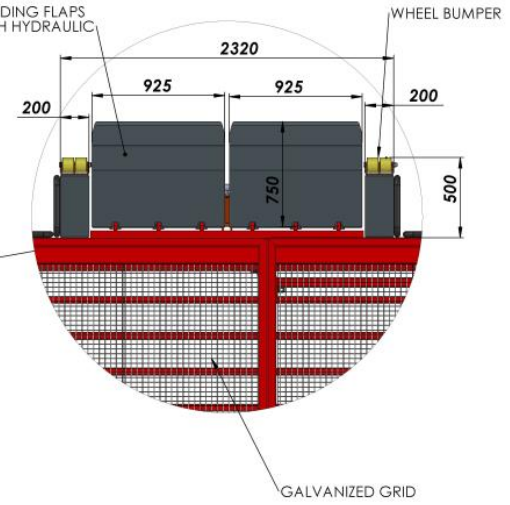
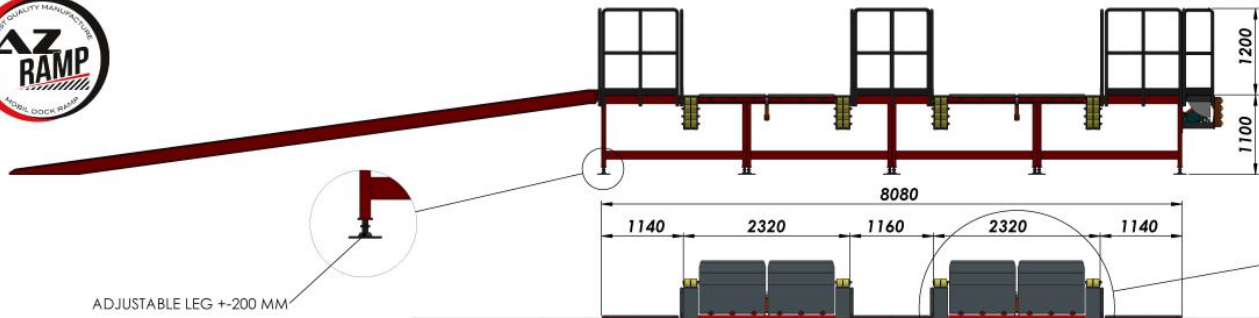

NAME -SURNAME	DATE	SIGN	QUANTITY	MASS (KG)	MATERIAL	PAGE NR
DRAWN BY H. CANSEVER	29.03.2022		---			1/2
CONTROL A. HEPBILDI	29.03.2022					
APPROVAL S. ENTZMANN	29.03.2022					
SCALE	1:100					
PART/ASSEMBLY NAME	DRAWING DESCRIPTION		DRAWING NO.			
	#E1BB CUSTOMIZED PLATFORM		---		4 7	

AZ MACHINERY
 AZ MACHINERY - SLU, Matériels d'Élévation et Manutention
 13 rue de la source - 66340 PALLATI DE CERBAGNOL - France
 Téléphone : +33 (0) 37 48 300 - contact@az-machinery.com - www.az-machinery.com
 Site : 824 654 958 (66) FR - TVA : FR02 824 654 958 - N° EORI : FR02 824 654 958



DRAWINGS

Rampes mobiles

Rampes fixes

Plateformes logistiques

Réhausse

Tables de quai mobiles

Tables de quai fixes

Passerelles

Rampes pour conteneurs

Niveleurs

Autres confections

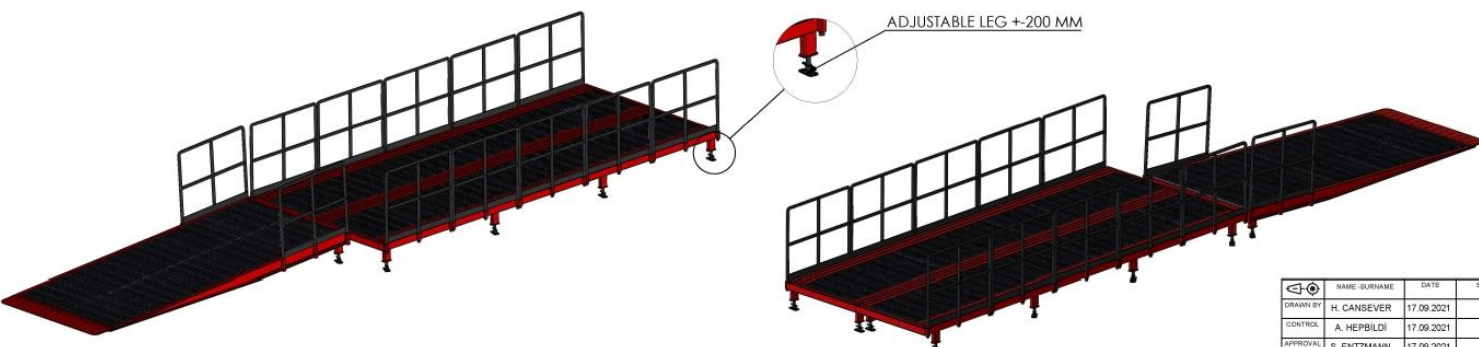
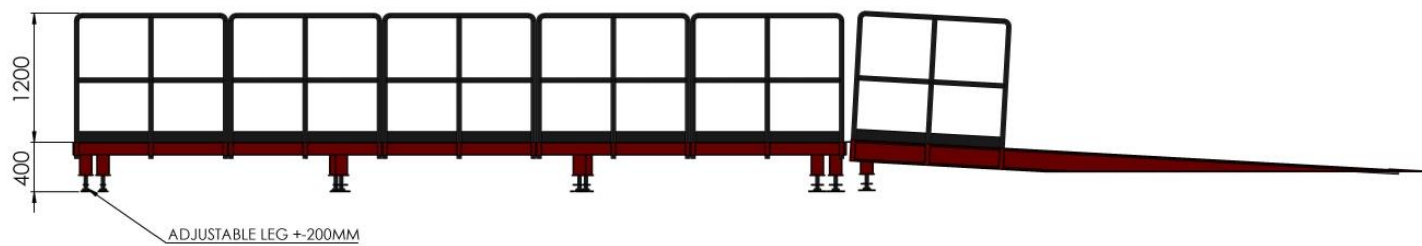
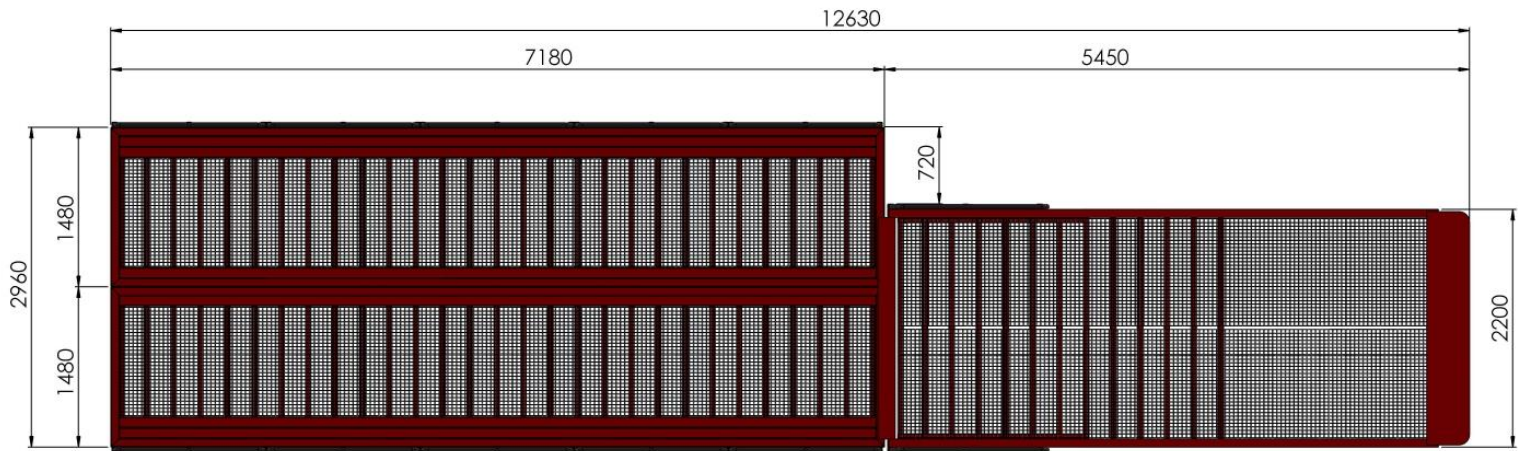

NAME	SURNAME	DATE	IGN	QUANTITY	MASS (KG)	MATERIAL	PAGE NR
DRAWN BY	H. CANSEVER	17.09.2021		---			1/1
CONTROL	A. HEPBILDI	17.09.2021					
APPROVAL	S. ENTZMANN	17.09.2021					
SCALE	1:50						
PART/ASSEMBLY NAME		DRAWING DESCRIPTION		DRAWING NO.			
		#E7BG LOW DOCK FRA-ORD-62		---			

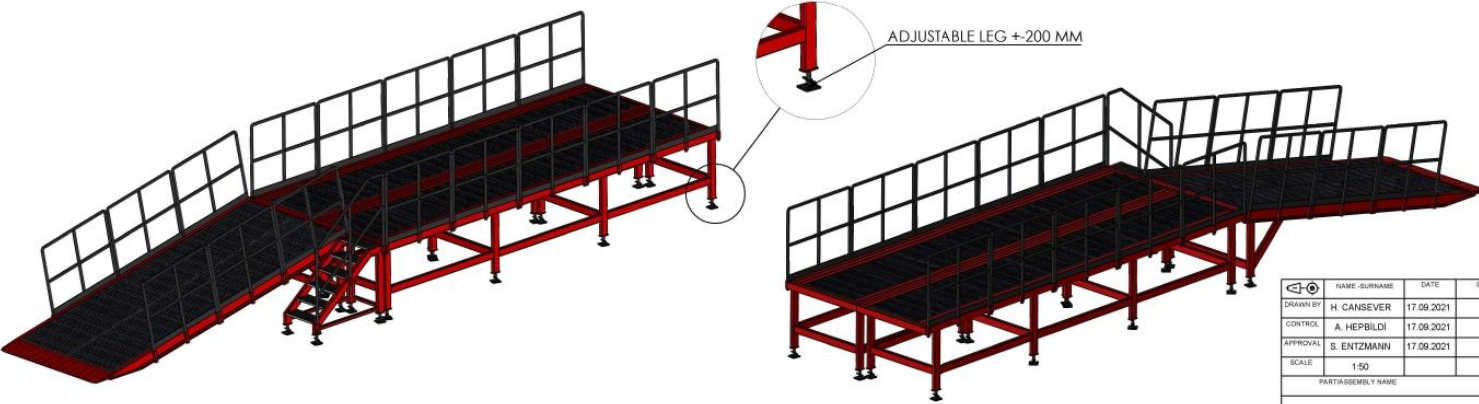
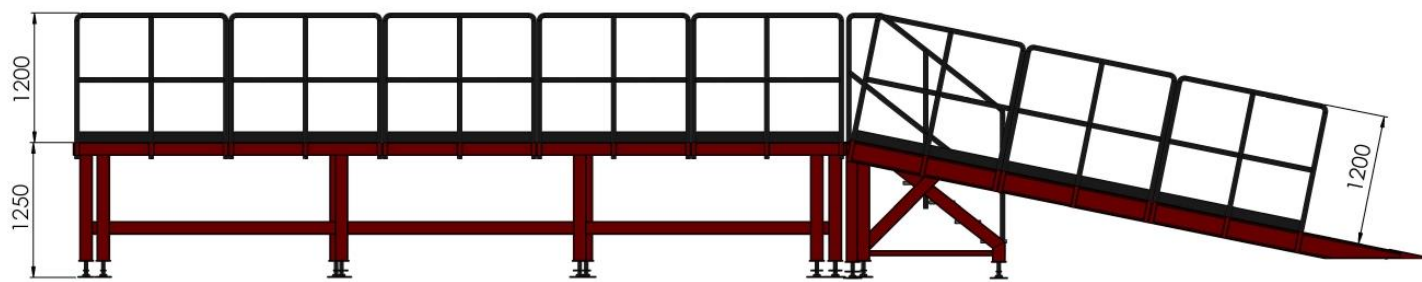
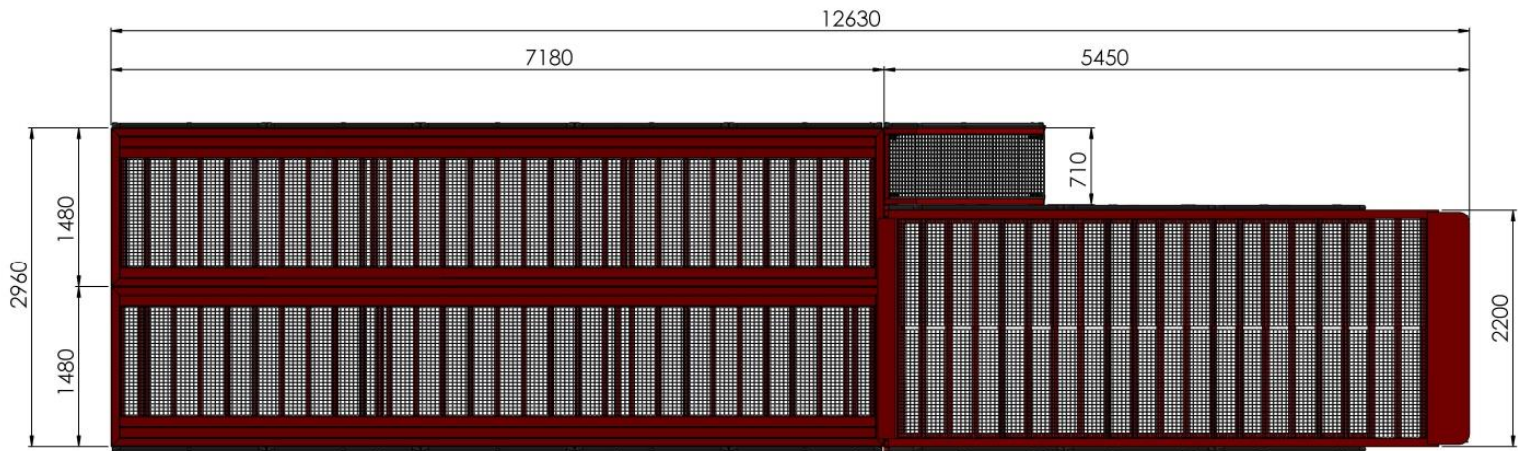

NAME-SURNAME	DATE	SIGN	QUANTITY	MASS (KG)	MATERIAL	PAGE NR
DRAWN BY H. CANSEVER	17.09.2021		---			1/1
CONTROL A. HEPBILDI	17.09.2021					
APPROVAL S. ENTZMANN	17.09.2021					
SCALE 1:50						
PART/ASSEMBLY NAME			DRAWING DESCRIPTION		DRAWING NO.	
			#E7BG LOW DOCK FRA-ORD-62		---	



AZ MACHINERY - SLU, Matériels d'Élévation et Manutention
 13 rue de la Vallée - 69360 PALAIS DE CÉREDAORD - France
 Téléphone : +33 (0) 47 41 50 00 - az.machinery.com - www.az-machinery.com
 Site : 824 034 038 00 15 - TVA : FR02 824 034 038 - N° EGDEI : FRAD 824 034 038

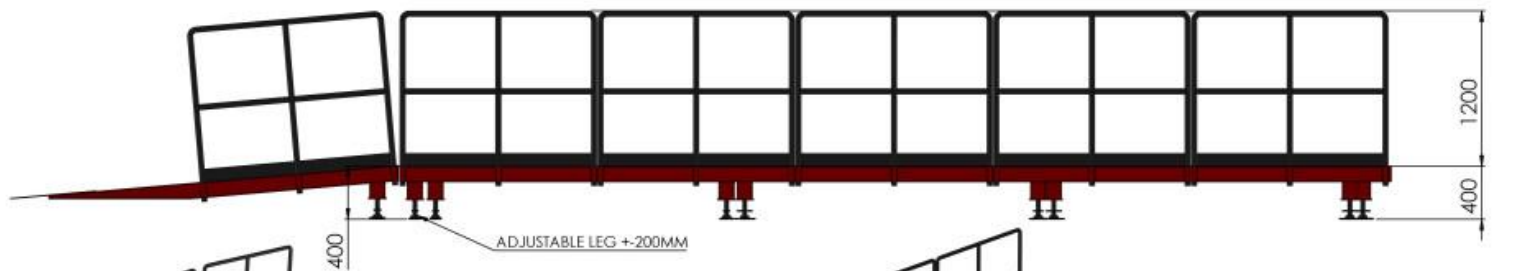
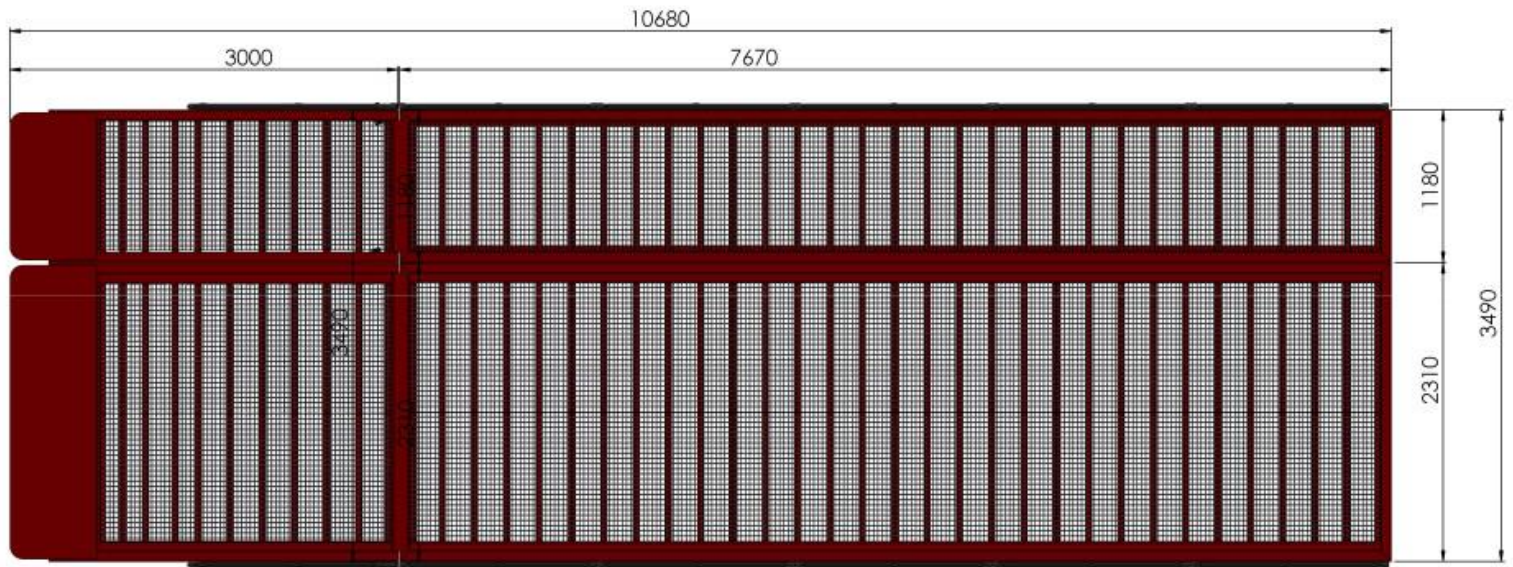

NO.	NAME (URNAM)	DATE	ISSUE	QUANTITY	MARKING	MATERIAL	PROG. NO.
01	H. CARBEVER	17.09.2021					1/1
02	A. HEPBLD	17.09.2021					
03	S. ENTZMANN	17.09.2021					
04							
05							
PARTS/ISSUESLY MARK			DRAWING DESCRIPTION			DRAWING NO.	
			#E7BG LOW DOCK, REV01 FRA-ORD-62			-	

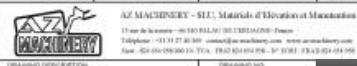

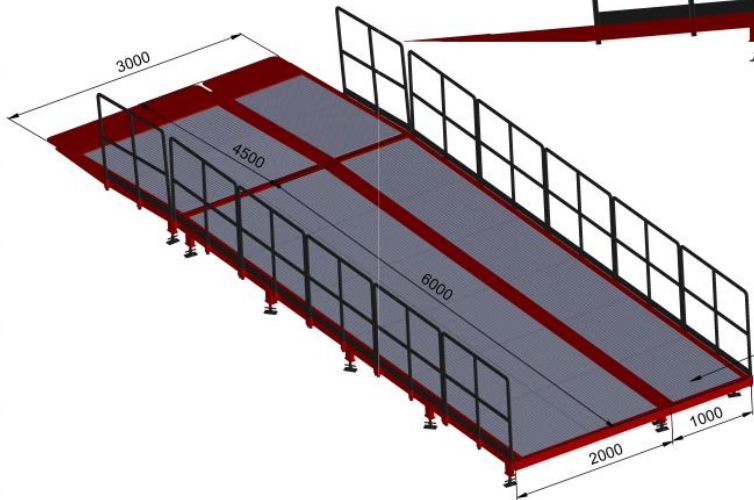
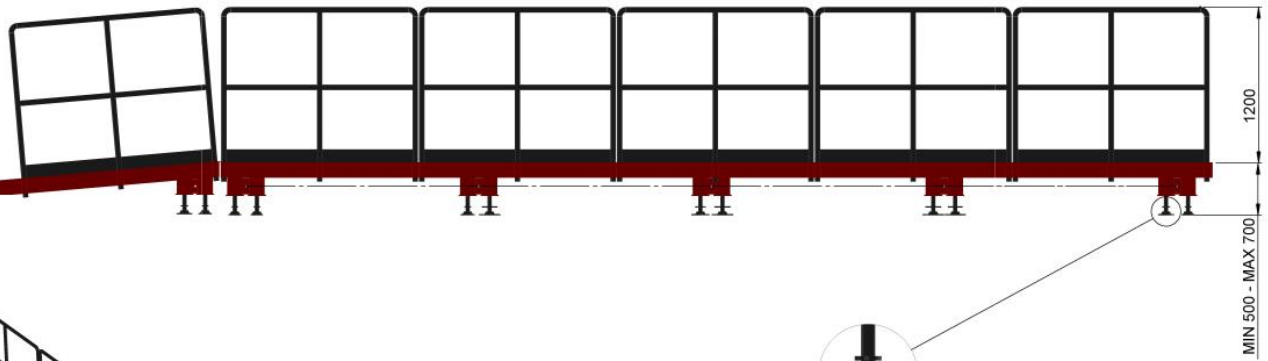
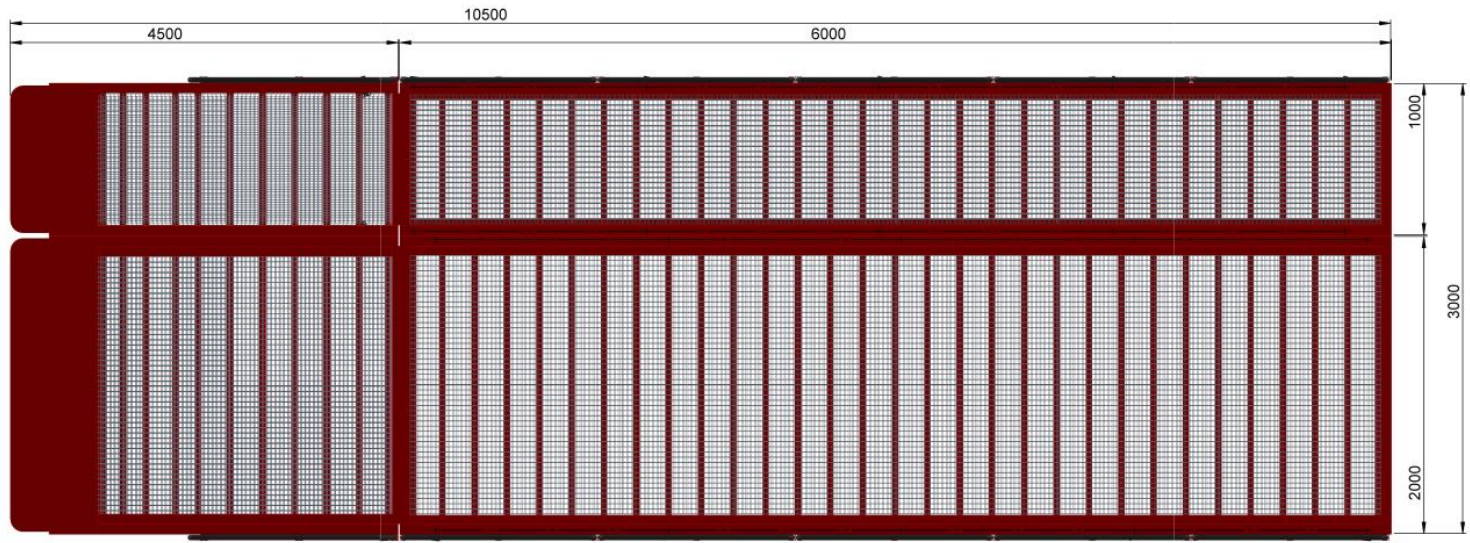

GALVANIZED GRID



GALVANIZED ADJUSTABLE LEG +200

NAME - SURNAME	DATE	SIGN	QUANTITY	MASS (KG)	MATERIAL	PAGE/NT
DRAWN BY B.QZ/C.FCI	---	---	---	---	---	1/1
CONTROL A.HEPBILDI	---	---	---	---	---	---
APPROVAL J.GUGUET	---	---	---	---	---	---
SCALE 1:50	---	---	---	---	---	---
PART/ASSEMBLY NAME		DRAWING DESCRIPTION			DRAWING NO.	
		# 9TDC				

AZ MACHINERY
AZ MACHINERY - SLU, Matériels d'Élévation et Maintenance
13 rue de la source - 16 540 PALLAS DE CÉREZANNE - France
Téléphone : +33 (0) 37 48 300 - contact@az-machinery.com - www.az-machinery.com
Site : 824 654 958 000 FR - TVA : FR02 824 654 958 - 3^e EOOB - FR03 824 654 958

5
2



DRAWINGS

Rampes mobiles
Rampes fixes
Plateformes logistiques
Réhausses
Tables de quai mobiles
Tables de quai fixes
Passerelles
Rampes pour conteneurs
Niveleurs
Autres confections

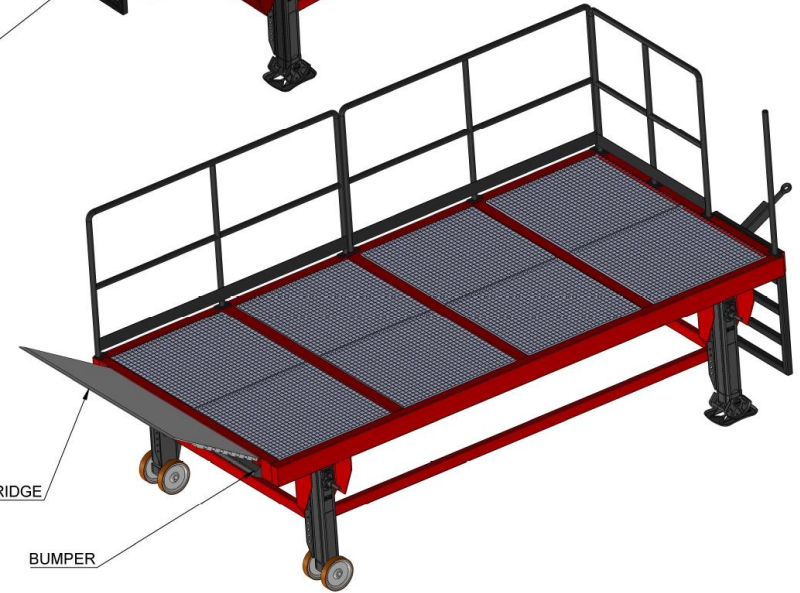
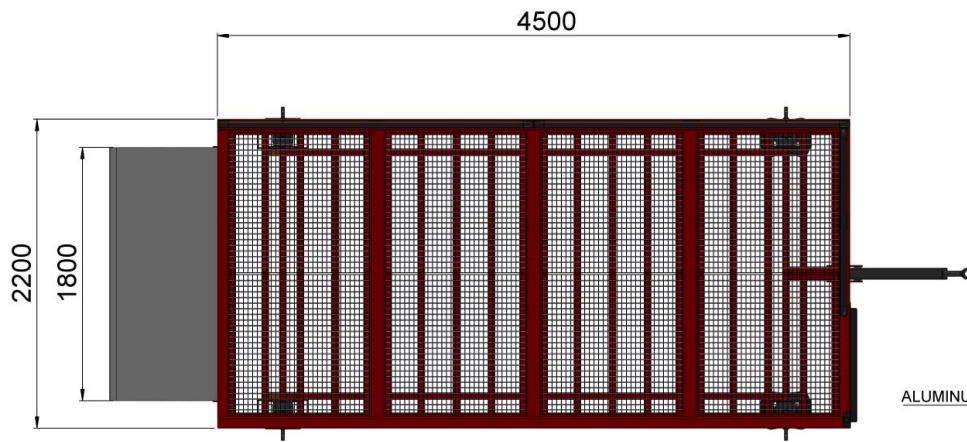
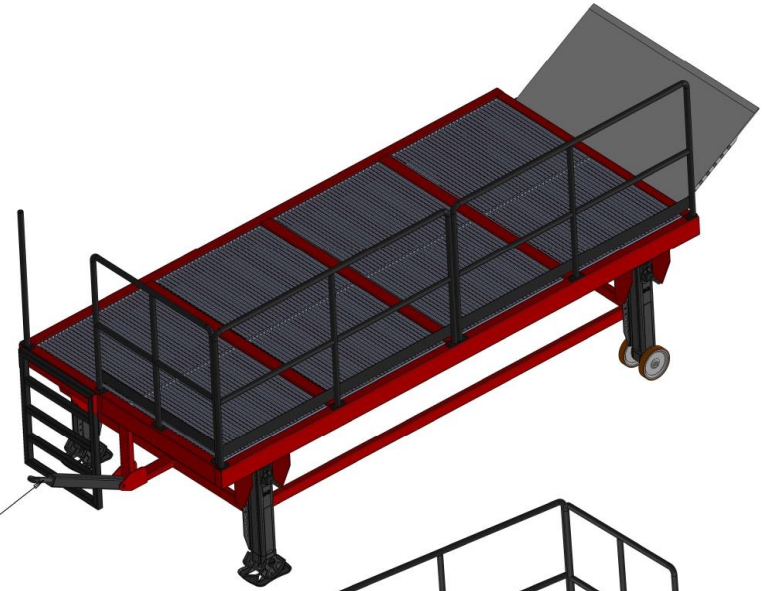
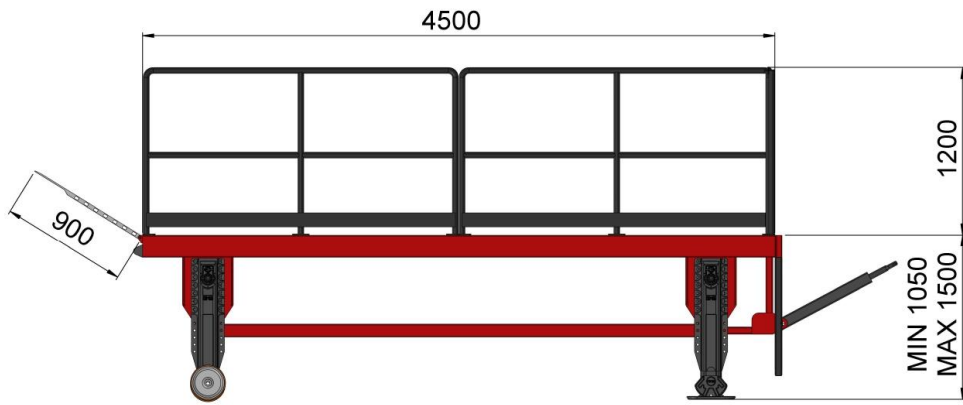

NAME-SURNAME	DATE	SIGN	QUANTITY	MASS (KG)	MATERIAL	PAGE NR
DRAWN BY H. CANSEVER	27.07.2021		---			1/1
CONTROL A. HEPBILDI	27.07.2021					
APPROVAL S. ENTZMANN	27.07.2021					
SCALE 1:50						
PART/ASSEMBLY NAME		DRAWING DESCRIPTION		DRAWING NO		
		FRA-ORD-52		---		



AZ MACHINERY - SLU, Matériels d'Élévation et Manutention
 13 rue de la scierie - 66 540 PALAU DE CERDANNES - France
 Téléphone : +33 (0) 27 46 505 - commercial@az-machinery.com - www.az-machinery.com
 Site : S24 654 958 000 10 - TVA : FR02 824 654 958 - NF E061 - FRAD 824 654 958

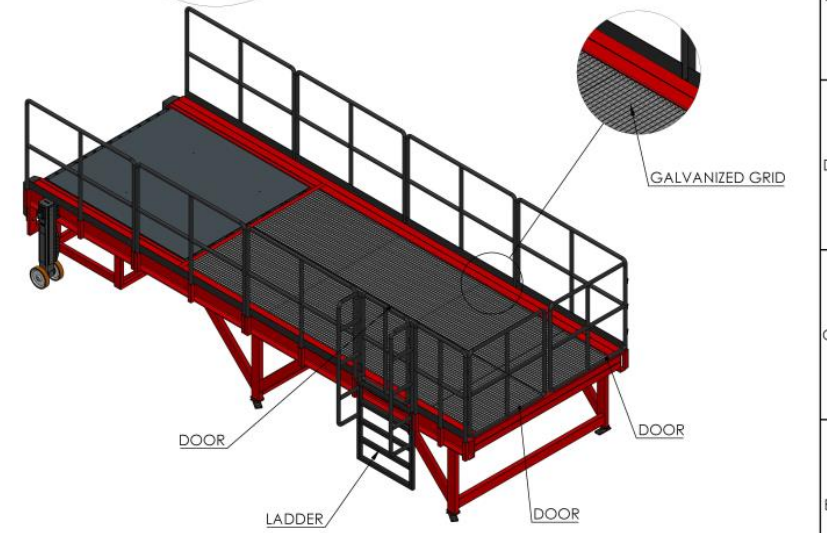
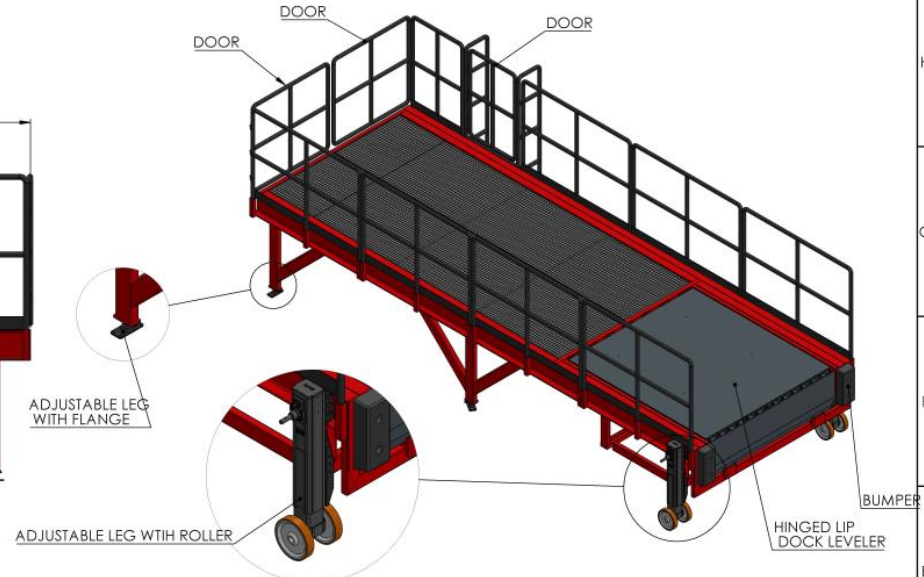
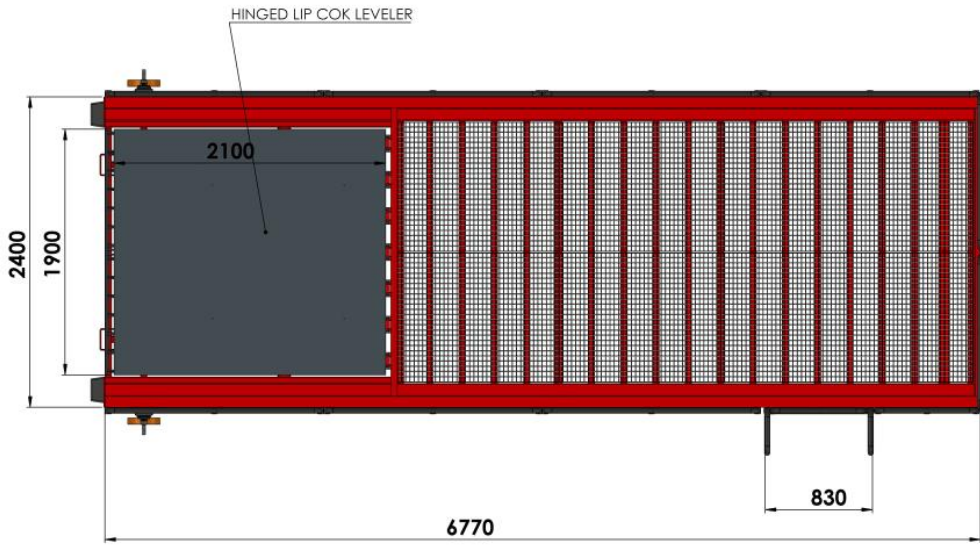
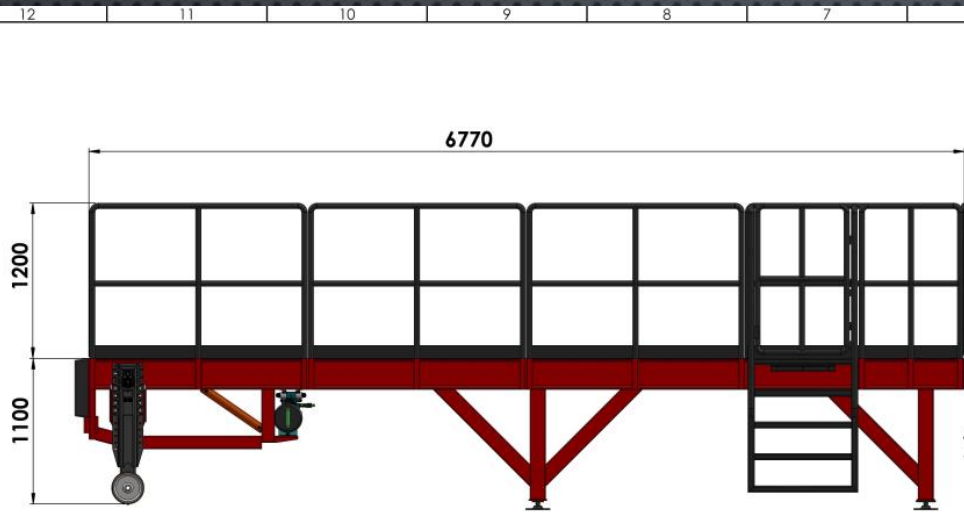

NAME - SURNAME	DATE	SIGN	QUANTITY	MASS (KG)	MATERIAL	PAGE NR
DRAWN BY H. CANSEVER	12.12.2021		---			1/1
CONTROL A. HEPBILDI	12.12.2021					
APPROVAL S. ENTZMANN	12.12.2021					
SCALE 1:50						
PARTASSEMBLY NAME	DRAWING DESCRIPTION:		DRAWING NO.			
	#74K7		---			

AZ MACHINERY
 AZ MACHINERY - SLU, Matériels d'Élévation et Maintenance
 13 rue de la source - 46 340 PULAY DE CEZEMANN - France
 Téléphone - 03 45 27 48 30 - contact@az-machinery.com - www.az-machinery.com
 Site - 02 45 458 000 FR - TVA - FR02 824 654 958 - N° EORI - FR02 824 654 958



DRAWINGS

Rampes mobiles
Rampes fixes
Plateformes logistiques
Réhausses
Tables de quai mobiles
Tables de quai fixes
Passerelles
Rampes pour conteneurs
Niveleurs
Autres confections

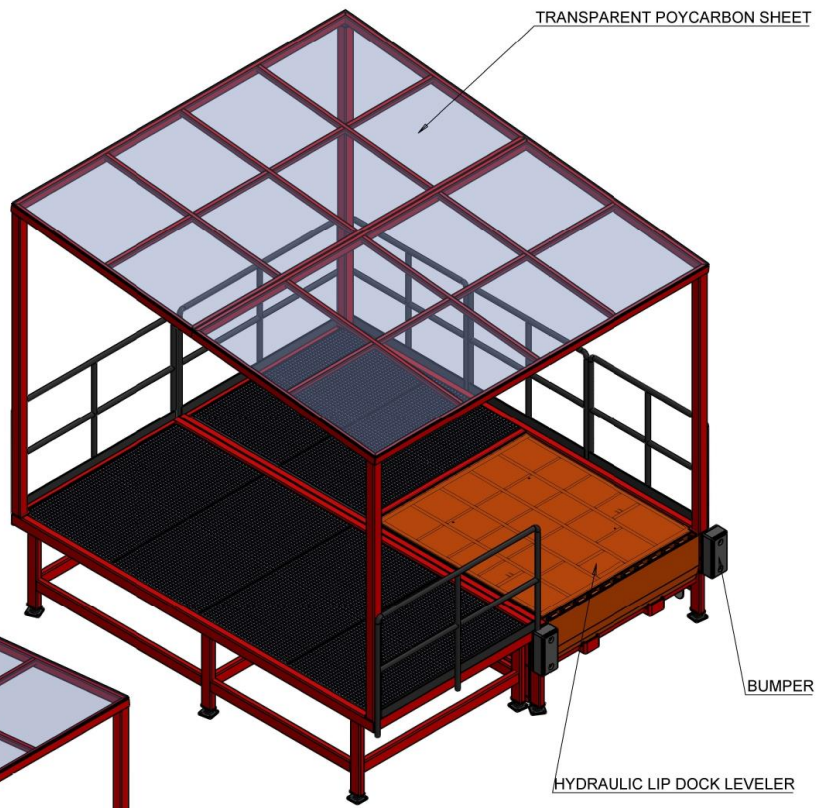
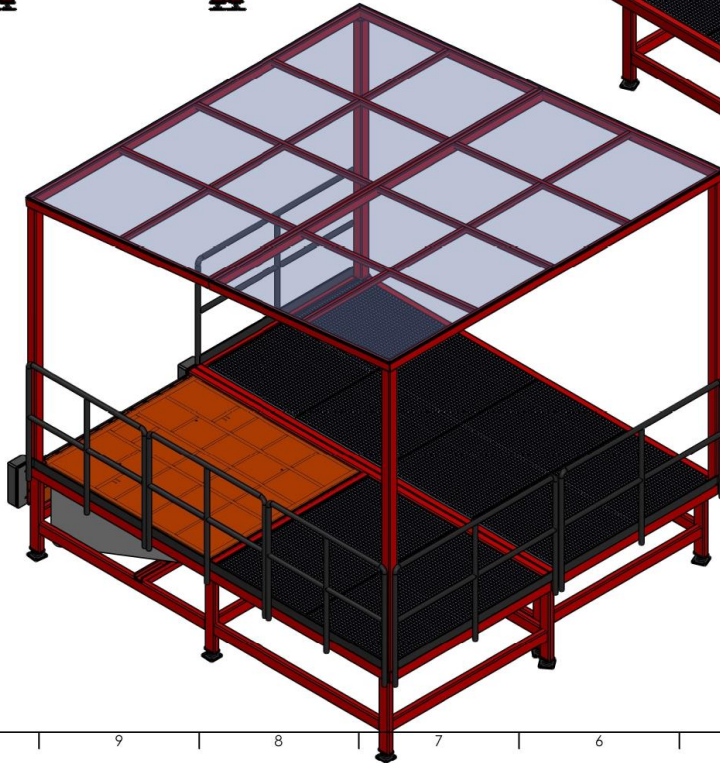
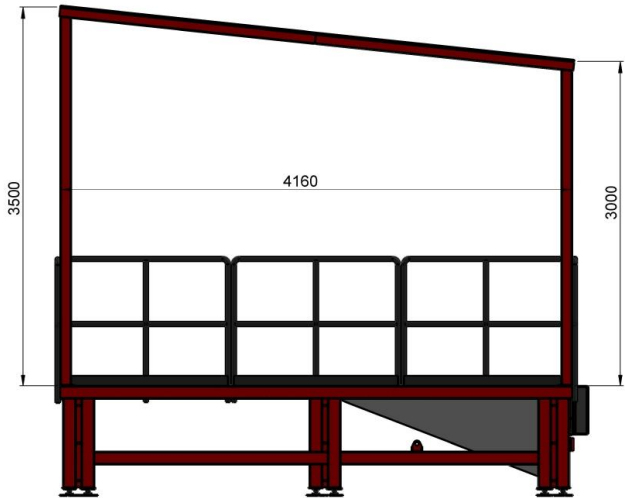

NAME-SURNAME	DATE	SIGN	QUANTITY	MASS (KG)	MATERIAL	PAGE NR
DRAWN BY H. CANSEVER	31.08.2021		---			1/1
CONTROL A. HEPBILDI	31.08.2021					
APPROVAL S. ENTZMANN	31.08.2021					
SCALE 1:50						
PARTASSEMBLY NAME			DRAWING DESCRIPTION		DRAWING NO	
			KARL&LEON WITH ROOF		---	

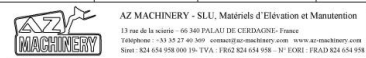

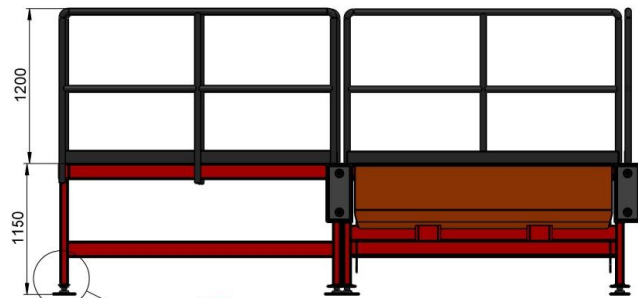

ADJUSTABLE LEG WITH FLANGE

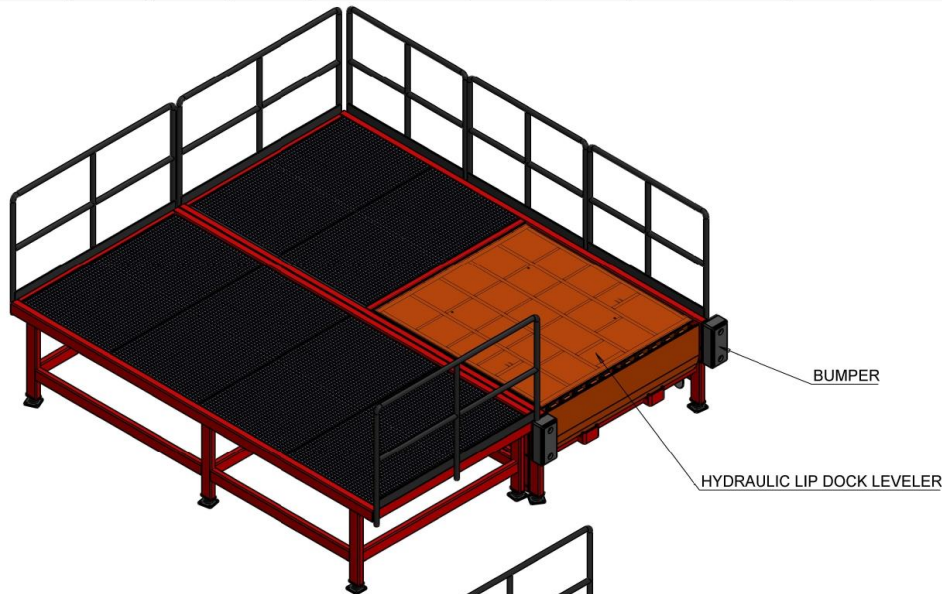
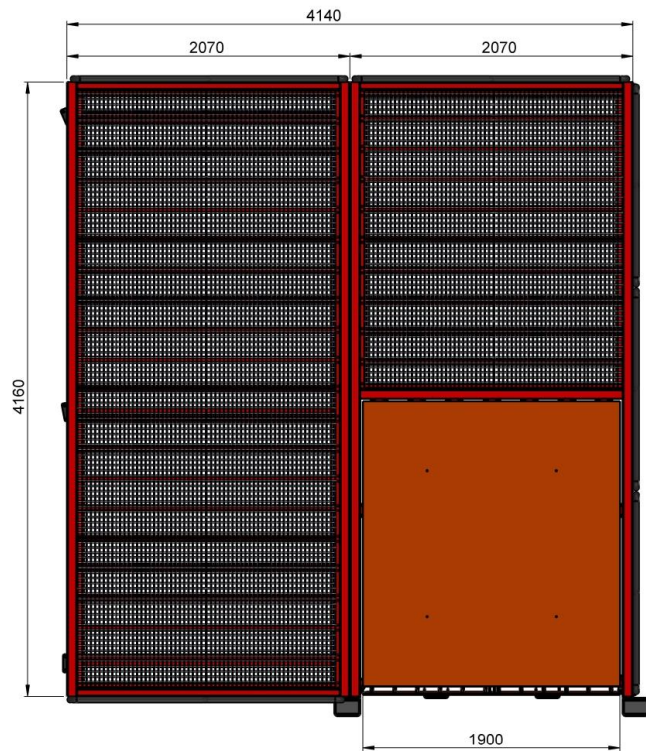

BUMPER

HYDRAULIC LIP DOCK LEVELER

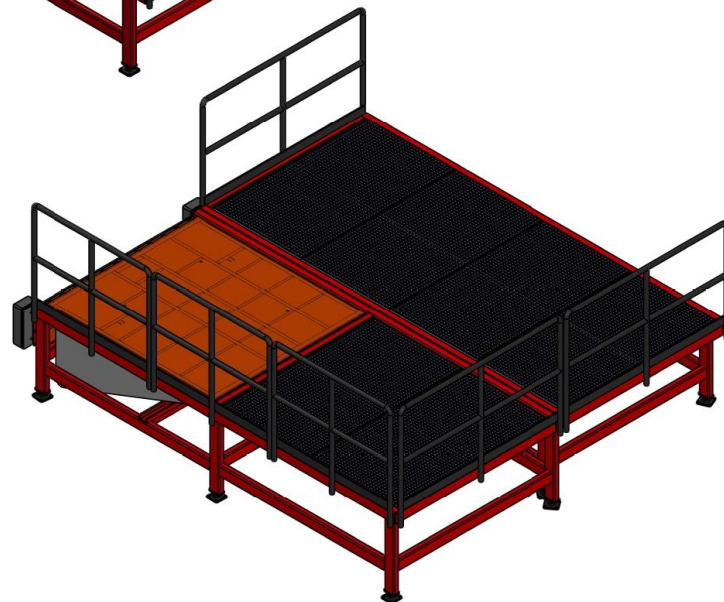

NAME-SURNAME	DATE	SIGN	QUANTITY	MASS (KG)	MATERIAL	PAGE NR
DRAWN BY H. CANSEVER	31.08.2021		---			1/1
CONTROL A. HEPBILDI	31.08.2021					
APPROVAL S. ENTZMANN	31.08.2021					
SCALE 1:50						
PART/ASSEMBLY NAME			DRAWING DESCRIPTION		DRAWING NO	
			KARL&LECN		---	



AZ MACHINERY - SLU, Matériels d'Élévation et Manutention
 13 rue de la scierie - 66100 PALLATI DE CERDAGNÈS - France
 Téléphone : +33 47 27 46 507 - contact@az-machinery.com - www.az-machinery.com
 Site : 324 654 958 000 10 - TVA : FR02 824 654 958 - 3^e EGEI - FRA02 824 654 958

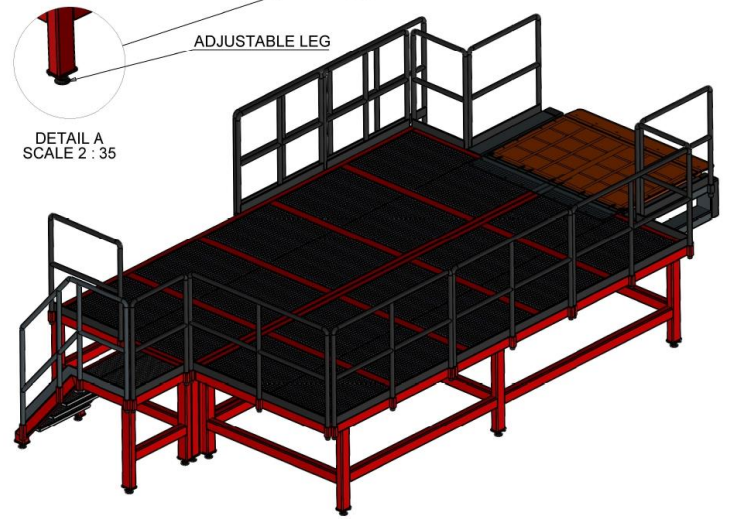
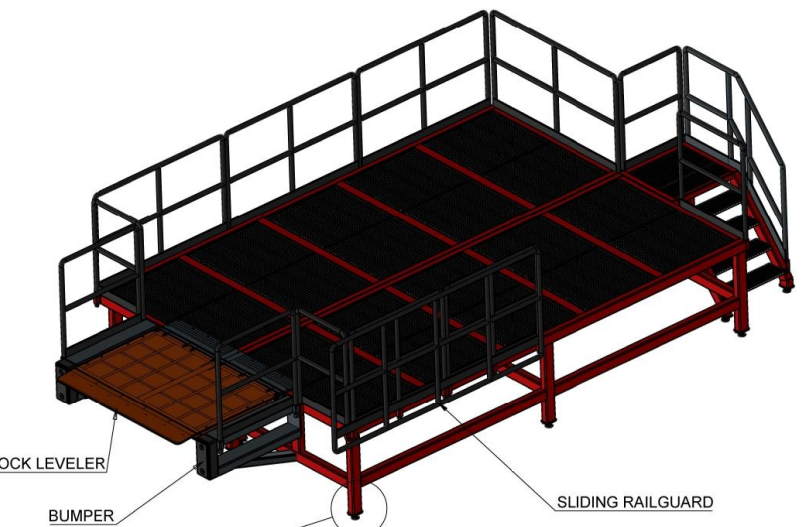
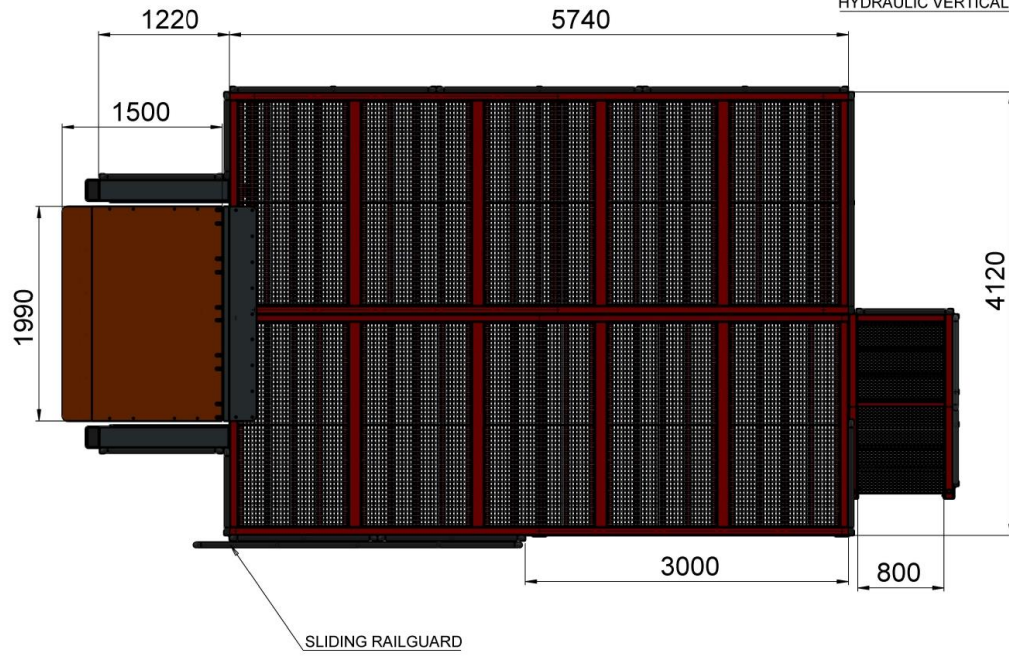
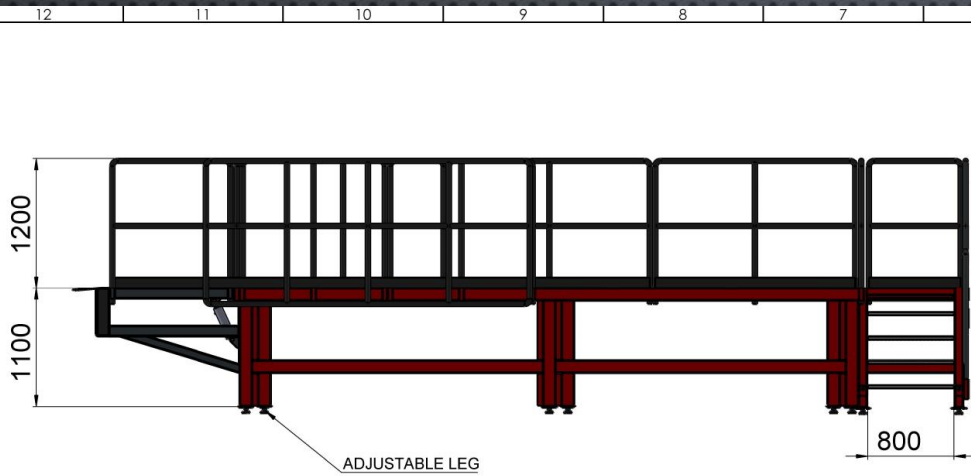

NAME-SURNAME	DATE	SIGN	QUANTITY	MASS (KG)	MATERIAL	PAGE NR
DRAWN BY H. CANSEVER	23.07.2021		---			1/1
CONTROL A. HEPBILDI	23.07.2021					
APPROVAL S. ENTZMANN	23.07.2021					
SCALE 1:50						
PART/ASSEMBLY NAME	DRAWING DESCRIPTION		DRAWING NO.			
	FRA-ORD-50		---			

AZ MACHINERY
AZ MACHINERY - SLU, Matériels d'Élévation et Maintenance
13 rue de la scierie - 60 340 PALAISEAU DE CERDAGNE - France
Téléphone : +33 32 27 46 300 - contact@az-machinery.com - www.az-machinery.com
Site : 324 654 958 000 10 - TVA : FR02 824 654 958 - 3^e EGEI - FRA02 824 654 958

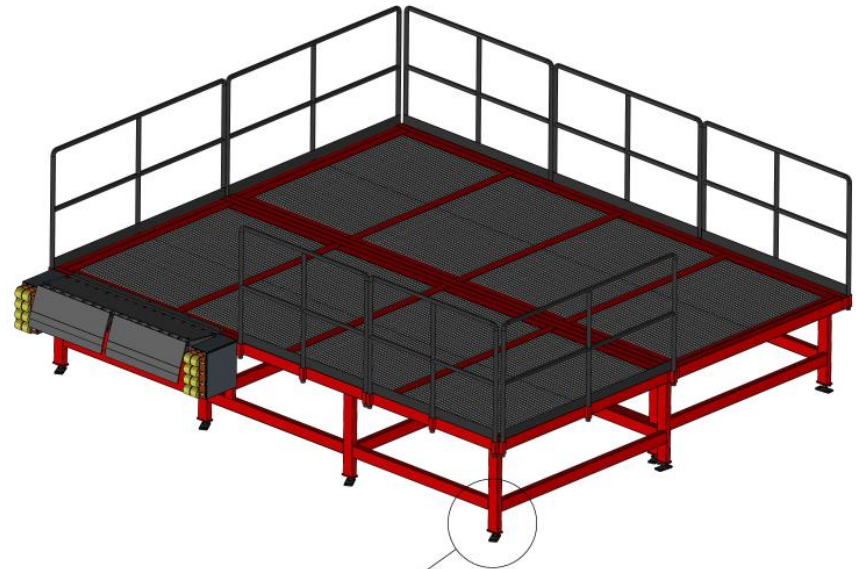
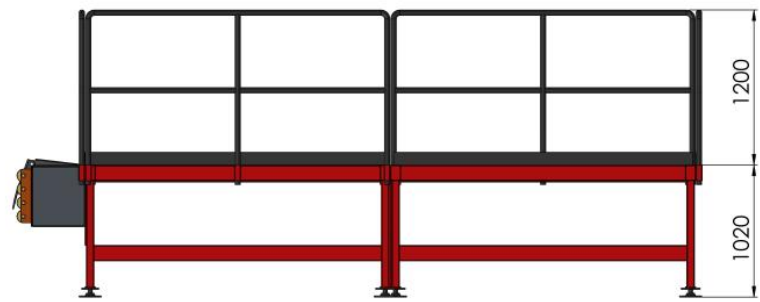
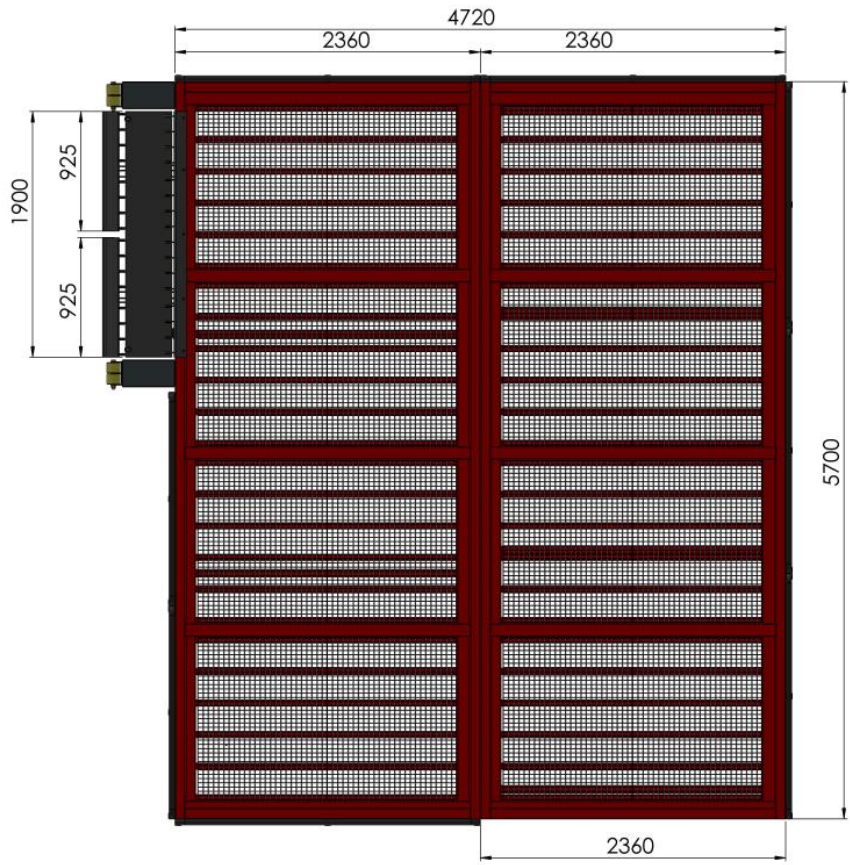

ADJUSTABLE LEG

NAME - SURNAME	DATE	SIGN	QUANTITY	MASS (KG)	MATERIAL	PAGE/SET
DRAWN BY: H. CANSEVER	07.09.2021		---			1/1
CONTROL: A. HEPBILDI	07.09.2021					
APPROVAL: S. ENTZMANN	07.09.2021					
SCALE: 1:50						
PART/ASSEMBLY NAME			DRAWING DESCRIPTION		DRAWING NO.	
			FRA-ORD-61 DOCK TABLE		---	



AZ MACHINERY - SLU, Matériels d'Élévation et Manutention
 13 rue de la source - 86 340 PALAIS DE CERAMIQUE - FRANCE
 Téléphone : +33 (0) 27 48 367 - contact@az-machinery.com - www.az-machinery.com
 Fax : 824 654 958 000 FR - TVA : FR02 824 654 958 - 3^e EGEI - FR03 824 654 958

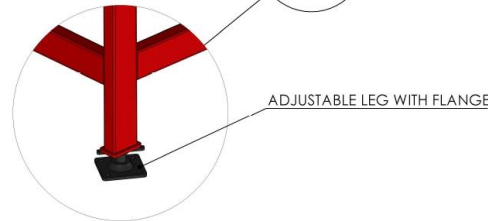
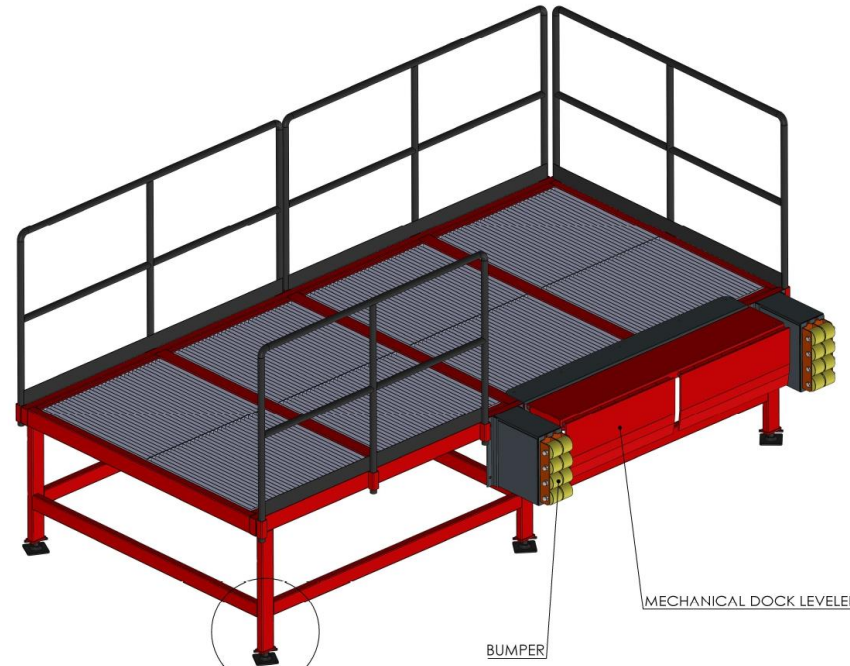
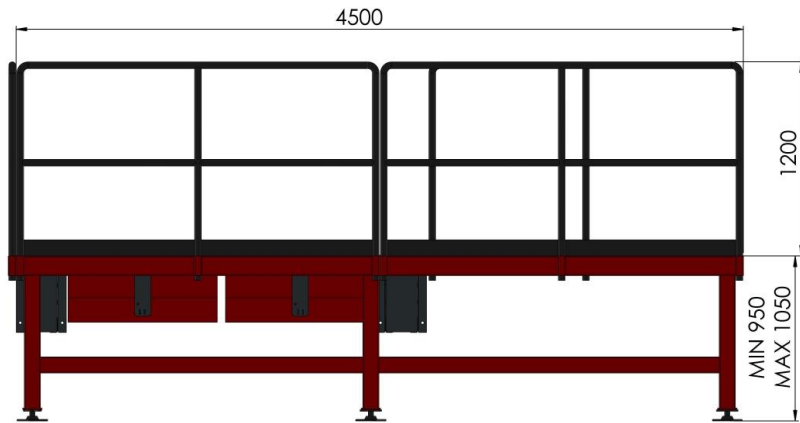
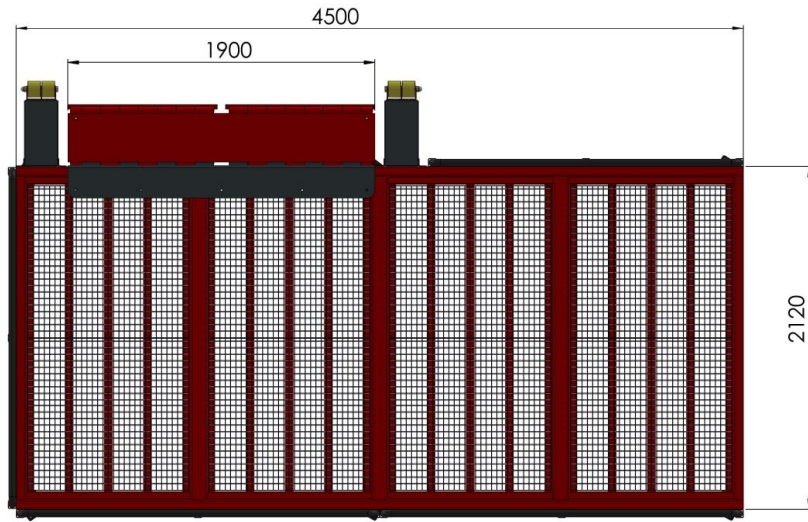

DETAIL A
SCALE 1 : 10

NAME - SURNAME	DATE	SIGN	QUANTITY	MASS (KG)	MATERIAL	PAGE NR
DRAWN BY H. CANSEVER	30.07.2021		---			1/1
CONTROL A. HEPBILDI	30.7.2021					
APPROVAL S. ENTZMANN	30.07.2021					
SCALE 1:50						
PART/ASSEMBLY NAME			DRAWING DESCRIPTION		DRAWING NO	
			FRA-ORD-55		---	



AZ MACHINERY - SLU, Matériels d'Élévation et Manutention
 13 rue de la scierie - 06340 PALAISEAU DE CERDAGNE - France
 Téléphone : +33 (0) 47 49 500 - contact@az-machinery.com - www.az-machinery.com
 Site : S24 654 958 000 19 - TVA : FR02 824 654 958 - N° EORI : FRAD 824 654 958

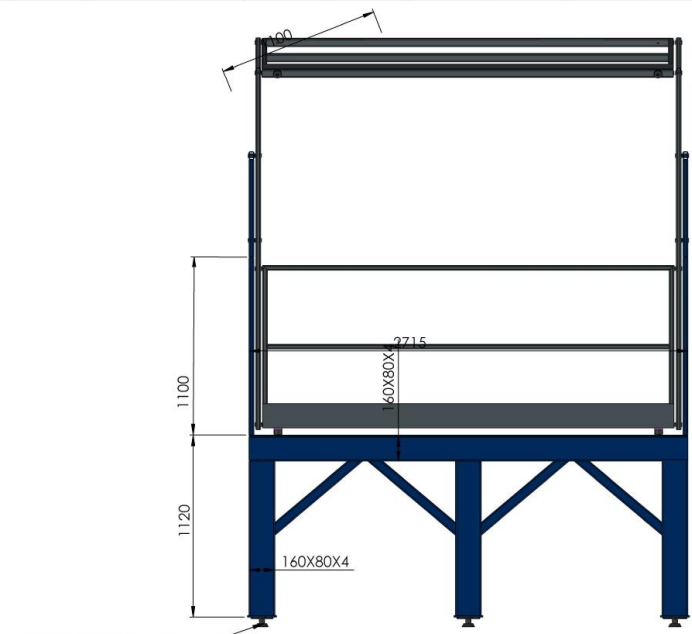
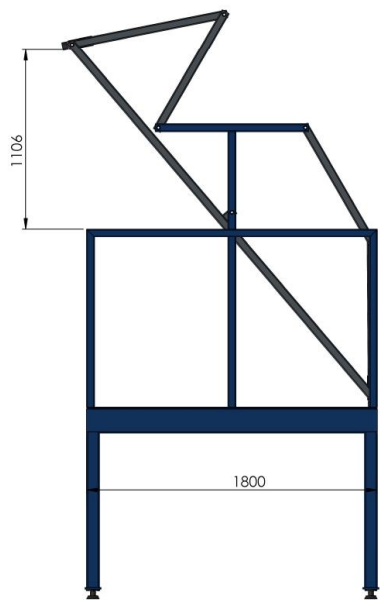

ADJUSTABLE LEG +150



ALL SURFACE IS 4/5 DROP PATTERN SHHT

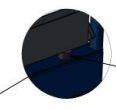
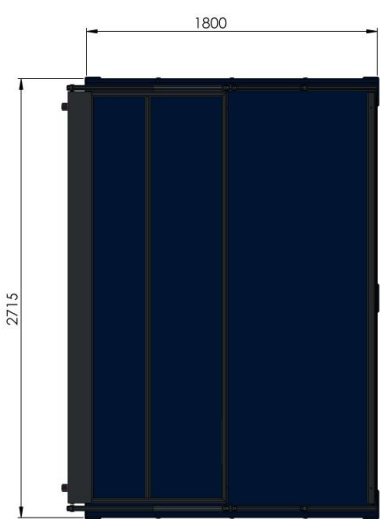

BUMPER

DETAIL B
SCALE 2 : 25

NAME-SURNAME	DATE	SIGN	QUANTITY	MASS (KG)	MATERIAL	PAGE NR
DRAWN BY N.HATIPOGLU	---	---	---			1/1
CONTROL H.CANSEVER	---	---				
APPROVAL K.TEKIN	---	---				
SCALE 1:50						
PARTASSEMBLY NAME			DRAWING DESCRIPTION		DRAWING NO	
			FRA-ORD-42 LAYOUT		---	



AZ MACHINERY - SLU, Matériels d'Élévation et Maintenance
 13 rue de la scierie - 06340 PALAISEAU DE CERDAGNE - France
 Téléphone : +33 (0) 27 48 500 - contact@az-machinery.com - www.az-machinery.com
 Site : S24 654 958 000 10 - TVA : FR02 824 654 958 - N° EORI : FR42 824 654 958



DRAWINGS

Rampes mobiles
Rampes fixes
Plateformes logistiques
Réhausses
Tables de quai mobiles
Tables de quai fixes
Passerelles
Rampes pour conteneurs
Niveleurs
Autres confections

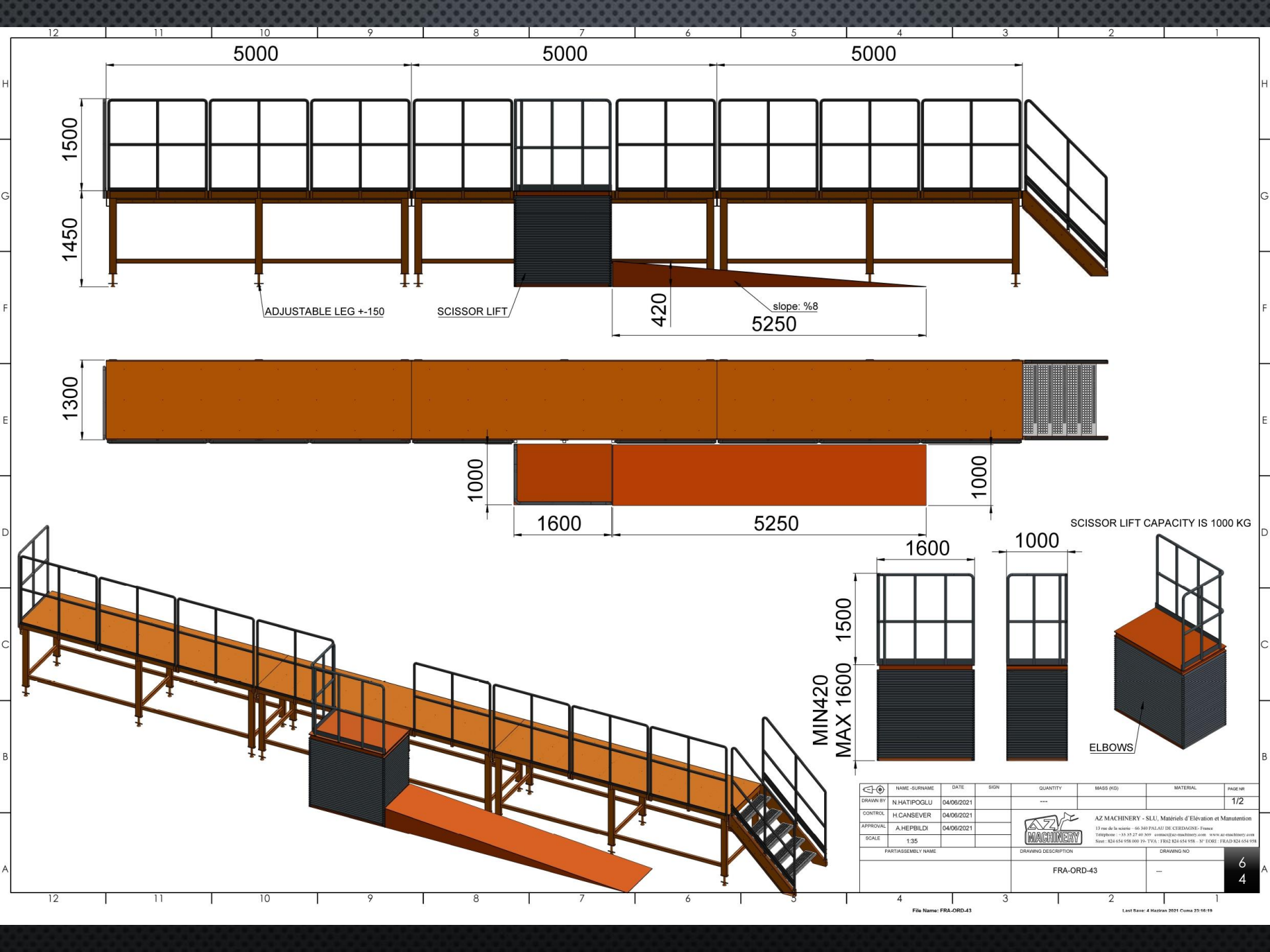

12 11 10 9 8 7 6 5 4 3 2 1

5000 5000 5000

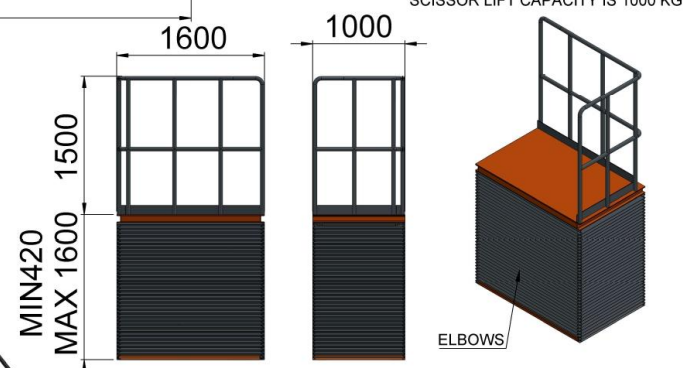
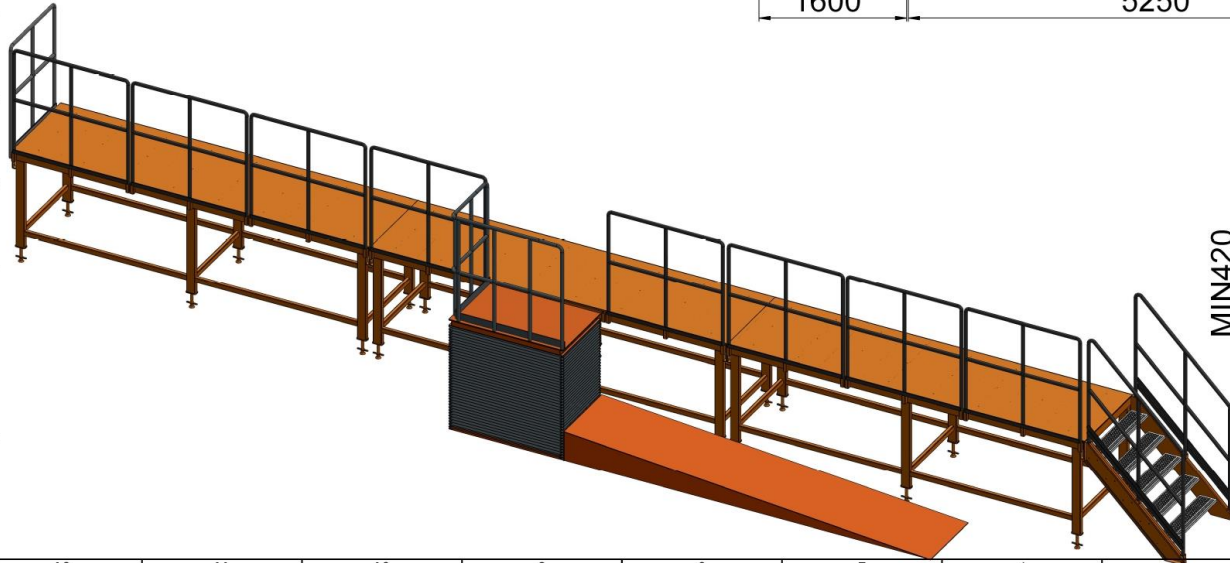
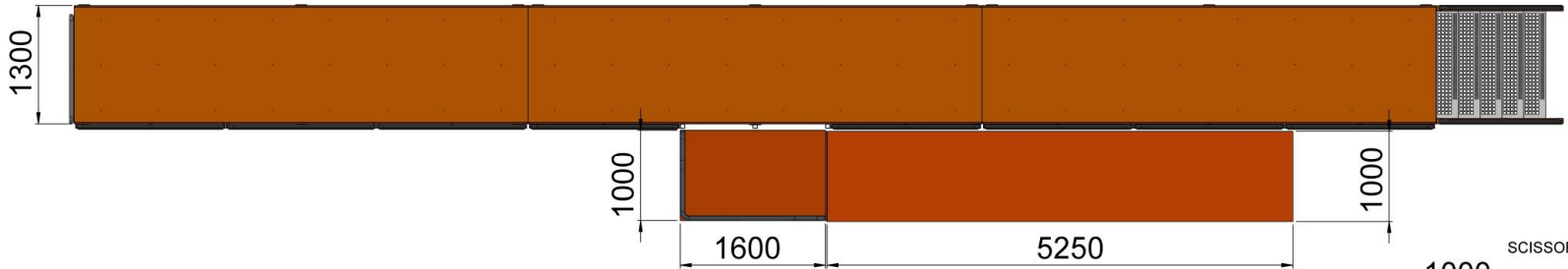
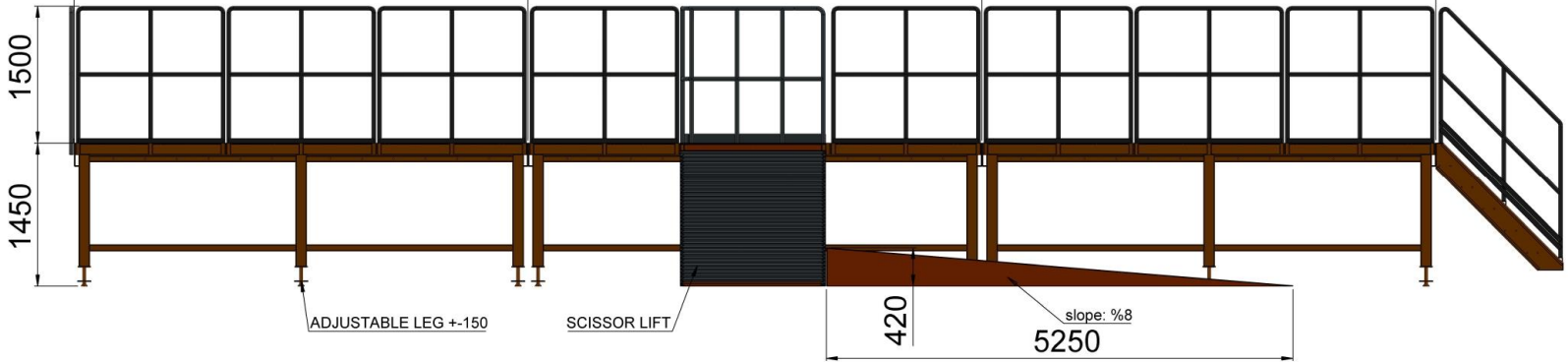

NAME-SURNAME	DATE	SIGN	QUANTITY	MASS (KG)	MATERIAL	PAGE NR
DRAWN BY N.HATIPOGLU	04/09/2021		---			1/2
CONTROL H.CANSEVER	04/09/2021					
APPROVAL A.HEPBILDI	04/09/2021					
SCALE 1:35						
PART/ASSEMBLY NAME	DRAWING DESCRIPTION		DRAWING NO			
	FRA-ORD-43		---			



DRAWINGS

Rampes mobiles
Rampes fixes
Plateformes logistiques
Réhausses
Tables de quai mobiles
Tables de quai fixes
Passerelles
Rampes pour conteneurs
Niveleurs
Autres confections

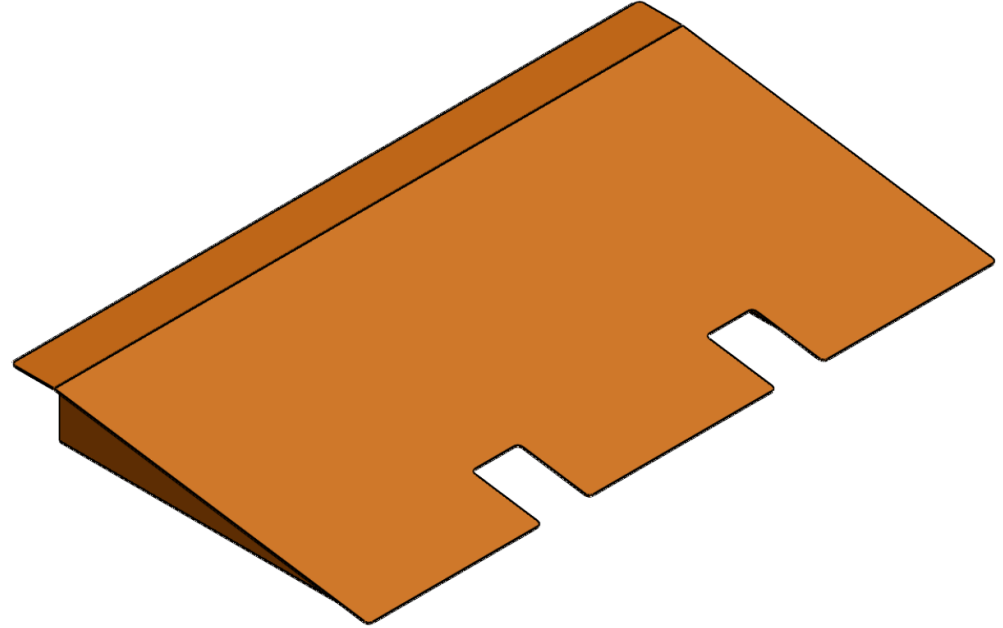
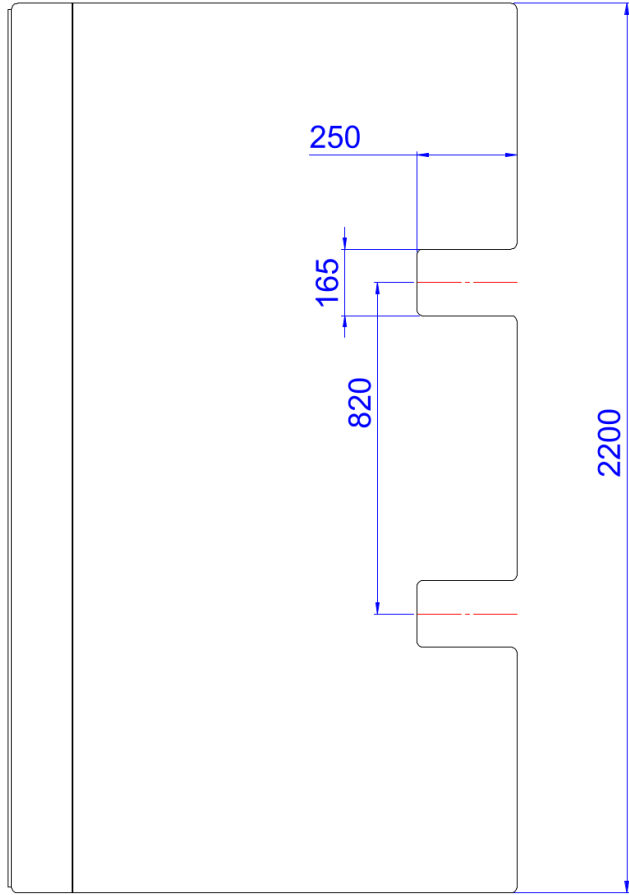
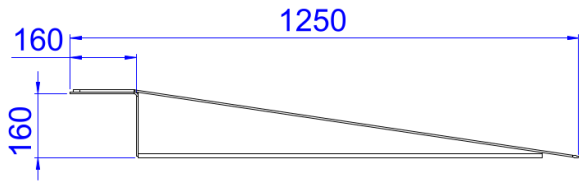

ADI - SOYADI NAME - SURNAME	TARİH DATE	İMZA SIGN	MİKTAR QUANTITY	AĞIRLIK (KG) WEIGHT (KG)	MALZEME MATERIAL	SAYFA NO PAGE NO
N.HATİPOĞLU	25/08/2021		---	200		1/1
KONTROL CONTROL	H.CANSEVER	25/08/2021				
ONAY APPROVAL	A.HEPBİLDİ	25/08/2021				
ÖLÇEK SCALE	1:8					
PARÇA/MONTAJ ADI PART/ASSEMBLY NAME			TEKNİK RESİM AÇIKLAMASI DRAWING DESCRIPTION			RESİM NO DRAWING NO
			CLR-2212			---



AZ MACHINERY - SLU, Matériels d'Élévation et Manutention
13 rue de la vicairie - 06 340 PÉRALAS DE CÉREACRENE - France
Téléphone : +33 (0) 27 46 100 - contact@az-machinery.com - www.az-machinery.com
Site : S24 654 958 000 10 - TVA : FR02 824 654 958 - N° EORI : FRAD 824 654 958

6
6

Dikkat 1- Resim üzerinden ölçü aleti ile ölçü almayın. 2- Formu veya ölçüsü değişen resimleri teknik büroya bildirin. 3- Resim üzerinde kontrol edenden başkası değişiklik yapamaz.

Dosya adı: CLR-2212

SON KAYIT TARİHİ: 25 Haziran 2021 Cuma 23:51:12

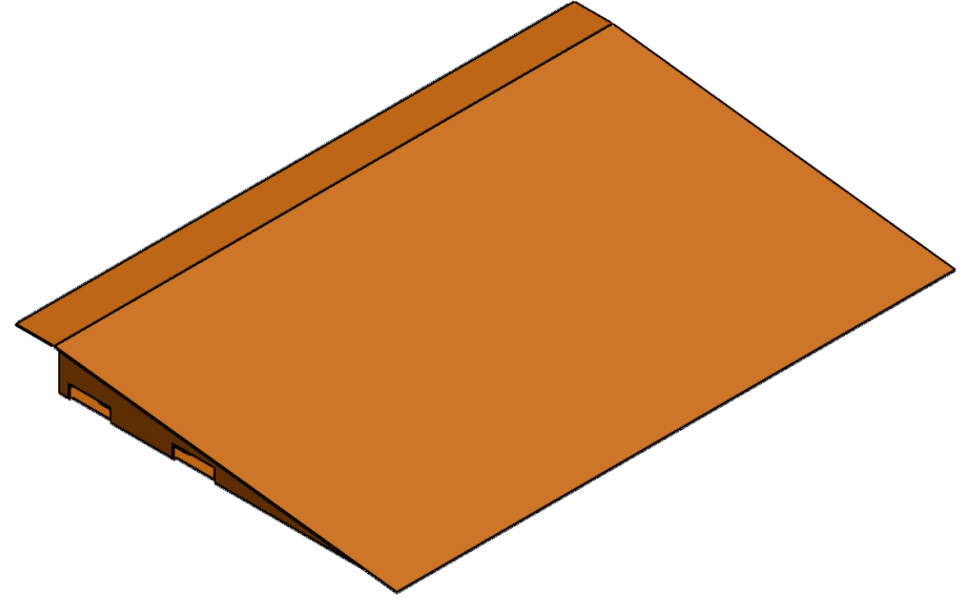
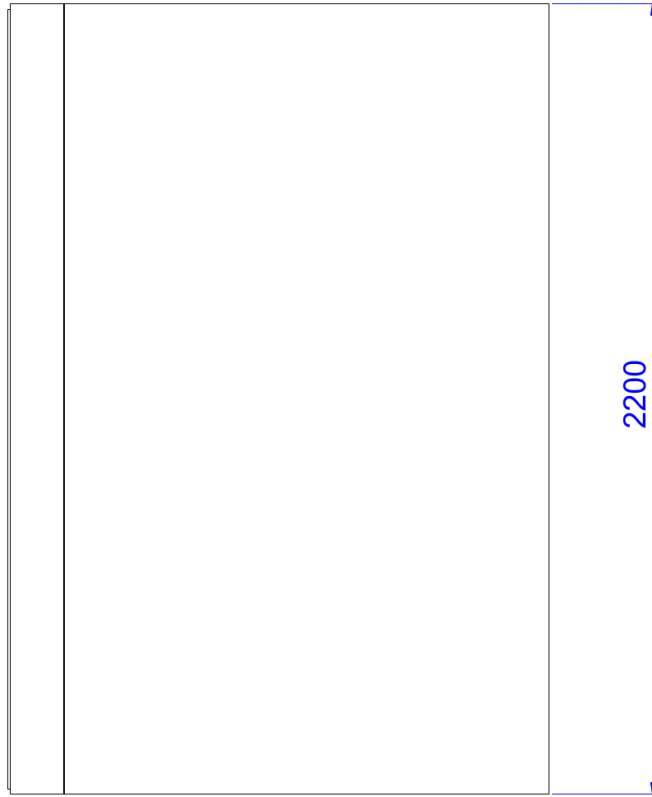
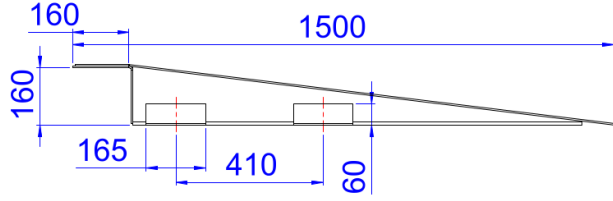

ADRES	ADI - SOYADI NAME - SURNAME	TARİH DATE	İMZA SIGN	MİKTAR QUANTITY	AĞIRLIK (KG) WEIGHT (KG)	MALZEME MATERIAL	SAYFA NO PAGE NO
ÇİZEN DRAWN BY	N.HATİPOĞLU	25/08/2021		---	230		1/1
KONTROL CONTROL	H.CANSEVER	25/08/2021					
ONAY APPROVAL	A.HEPBİLDİ	25/08/2021					
ÖLÇEK SCALE	1:9						
PARÇA/MONTAJ ADI PART/ASSEMBLY NAME				TEKNİK RESİM AÇIKLAMASI DRAWING DESCRIPTION			RESİM NO DRAWING NO
				CLR-2215			---



AZ MACHINERY - SLU, Matériels d'Élévation et Manutention
13 rue de la scierie - 66340 PALAISEAU - FRANCE
Téléphone : +33 37 37 46 100 - contact@az-machinery.com - www.az-machinery.com
Site : S24 654 958 000 19 - TVA : FR02 824 654 958 - N° EORI : FR02 824 654 958

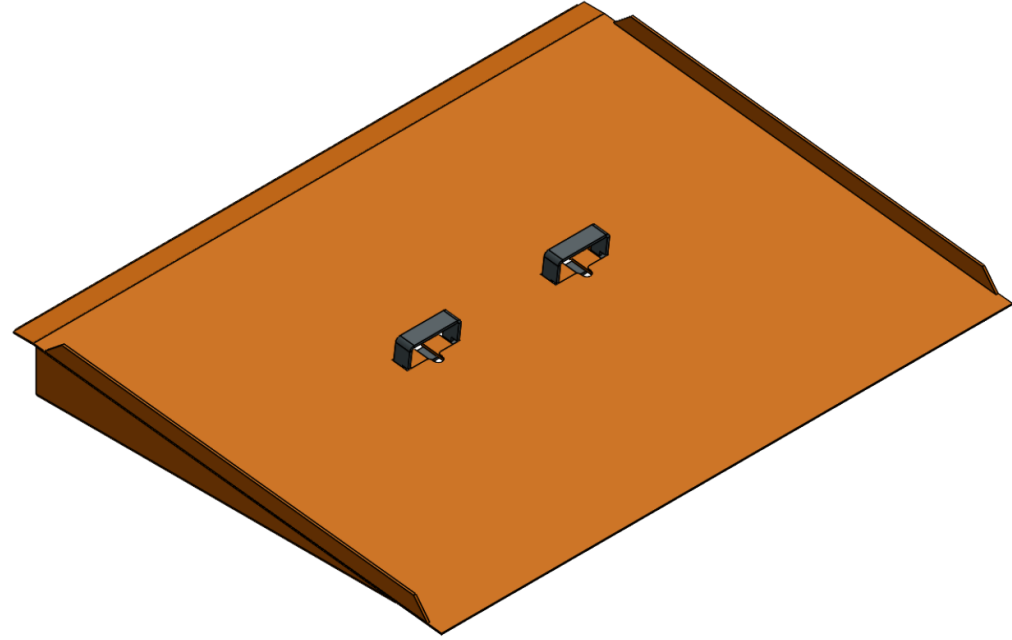
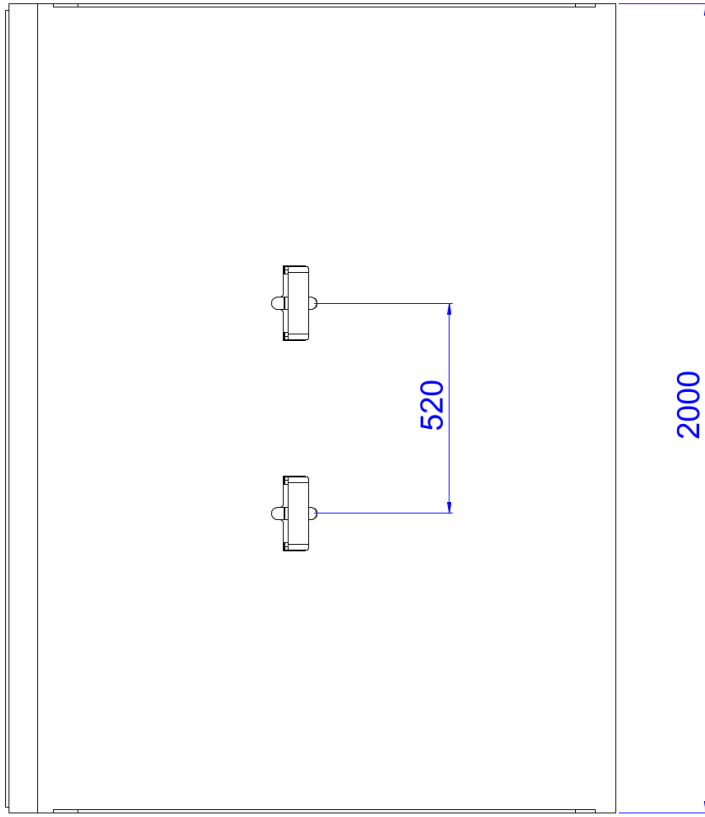
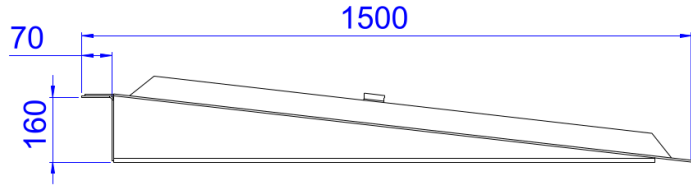

ADI - SOYADI NAME - SURNAME	TARİH DATE	İMZA SIGN	MİKTAR QUANTITY	AĞIRLIK (KG) MASS (KG)	MALZEME MATERIAL	SAYFA NO PAGE NO
ŞEHİN SHAHİN	25/08/2021		---	280		1/1
KONTROL CONTROL	H.CANSEVER	25/08/2021				
ONAY APPROVAL	A.HEPBİLDİ	25/08/2021				
ÖLÇEK SCALE	1:8					
PARÇA MONTAJ ADI PART ASSEMBLY NAME			TEKNİK RESİM AÇIKLAMASI DRAWING DESCRIPTION		RESİM NO DRAWING NO	
			CLR-2015		---	



AZ MACHINERY - SLU, Matériels d'Élévation et Manutention
13 rue de la vicairie - 06 340 PÉLASSIÈRE - FRANCE
Téléphone : +33 (0) 27 46 1001 - contact@az-machinery.com - www.az-machinery.com
Site : 024 654 958 000 10 - TVA : FR02 824 654 958 - N° ECRIS : FRAD 824 654 958

6
8

Dikkat 1- Resim üzerinden ölçü aleti ile ölçü almayın. 2- Formu veya ölçüsü değişen resimleri teknik büroya bildirin. 3- Resim üzerinde kontrol edenden başkası değişiklik yapamaz.

Dosya adı: CLR-2015

SON KAYIT TARİHİ: 25 Haziran 2021 Çizim 23:16:41

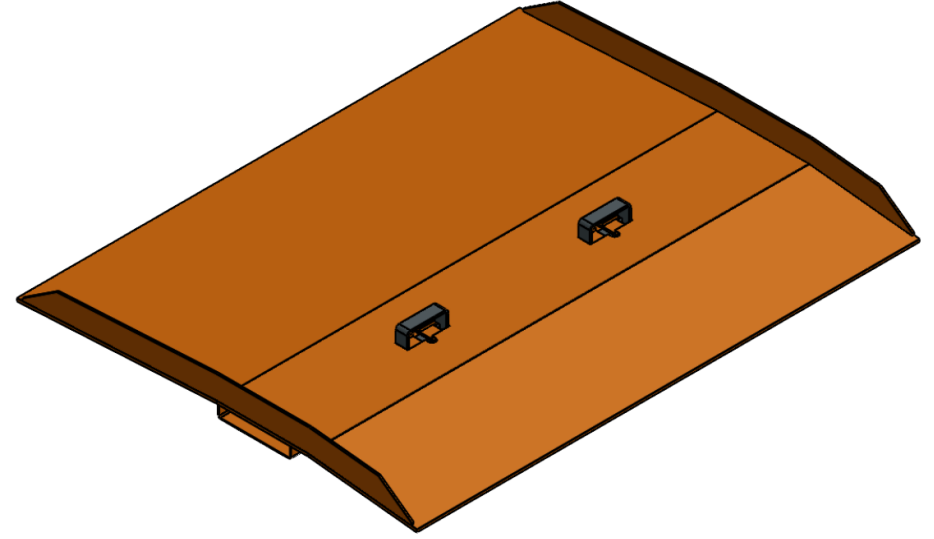
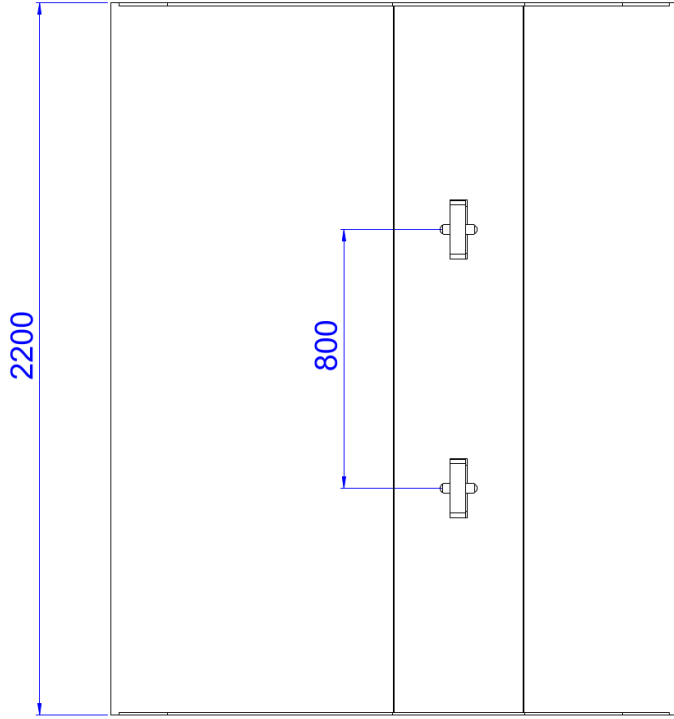
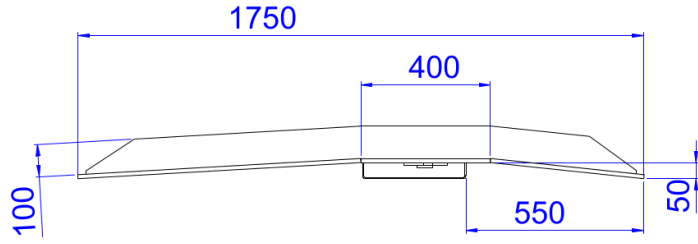

ADL - SOYADI NAME - SURNAME	TARİH DATE	İMZA SIGN	MİKTAR QUANTITY	AĞIRLIK (KG) WEIGHT (KG)	MALZEME MATERIAL	SAYFA NO PAGE NO
ŞEHİN SHAHİN	25/08/2021		---	430		1/1
KONTROL CONTROL	H.CANSEVER	25/08/2021				
ONAY APPROVAL	A.HEPBİLDİ	25/08/2021				
ÖLÇEK SCALE	1:10					
PARÇA/MONTAJ ADI PART/ASSEMBLY NAME			TEKNİK RESİM AÇIKLAMASI DRAWING DESCRIPTION		RESİM NO DRAWING NO	
			CLR-2017		---	



AZ MACHINERY - SLU, Matériels d'Élévation et Manutention
13 rue de la vicairie - 06 340 PALAISEAU DE CERÉACRENS - France
Téléphone : +33 (0) 27 46 100 - contact@az-machinery.com - www.az-machinery.com
Site : 024 654 958 000 19 - TVA : FR02 824 654 958 - N° EORI : FR02 824 654 958

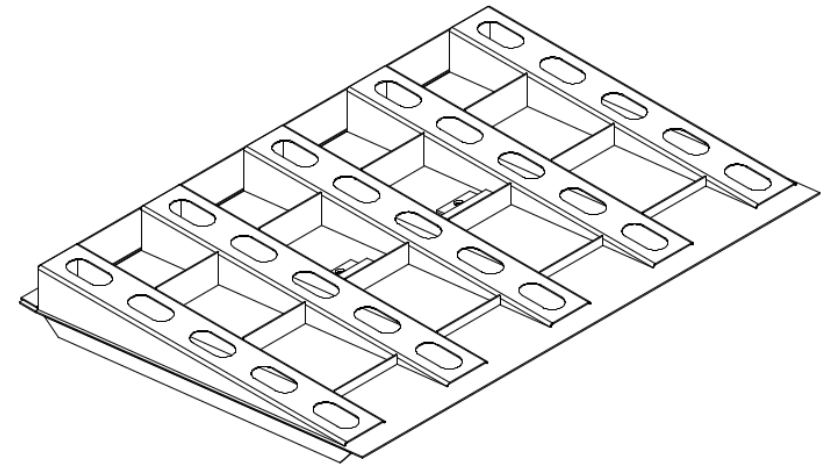
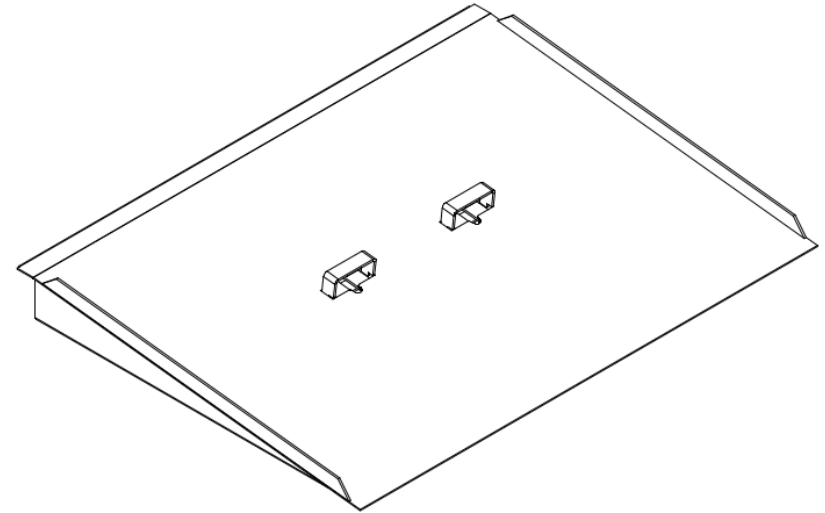
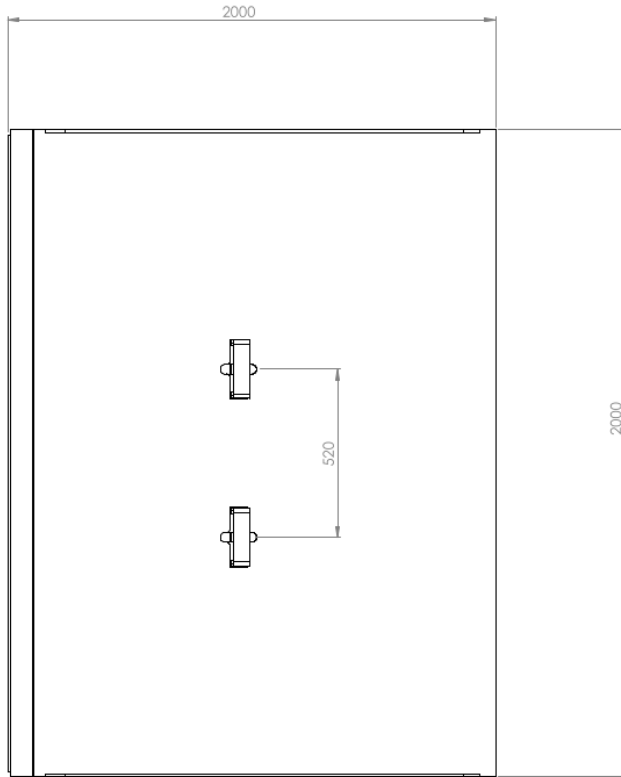
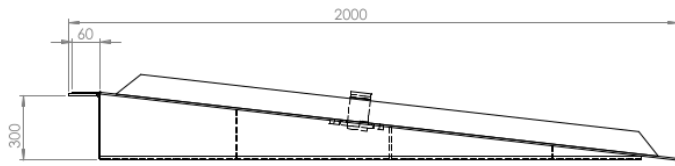

NAME - SURNAME	DATE	SIGN	QUANTITY	MASS (KG)	MATERIAL	PROCESS
DRAWN BY: N.HATIPOGLU	---	---	---	---	---	1/1
CONTROL: H.CANSEVER	---	---	---	---	---	---
APPROVAL: K.TEKIN	---	---	---	---	---	---
SCALE: 1:20	---	---	---	---	---	---
PART/ASSEMBLY NAME	DRAWING DESCRIPTION		DRAWING NO.			
---	#74K7		---			



AZ MACHINERY - SLU, Matériels d'Élévation et Maintenance
 13 rue de la scierie - 06 540 PALAISEAU DE CERDAGNE - France
 Téléphone : +33 (0) 47 46 1001 - contact@az-machinery.com - www.az-machinery.com
 Site : S24 654 958 000 19 - TVA : FR02 824 654 958 - N° EORI : FRAD 824 654 958

12 11 10 9 8 7 6 5 4 3 2 1

H
G
F
E
D
C
B
A

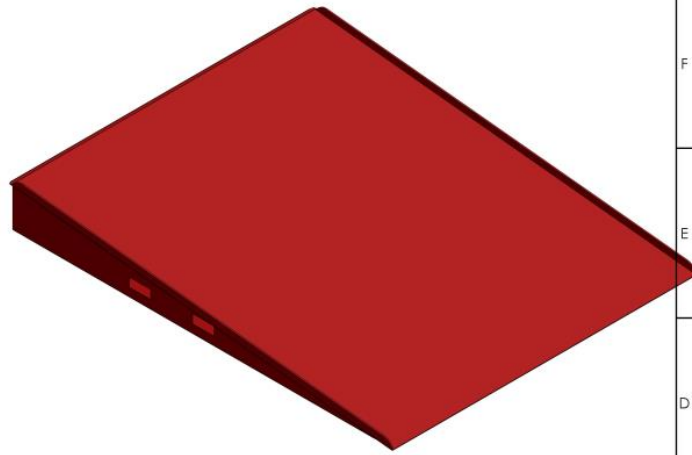
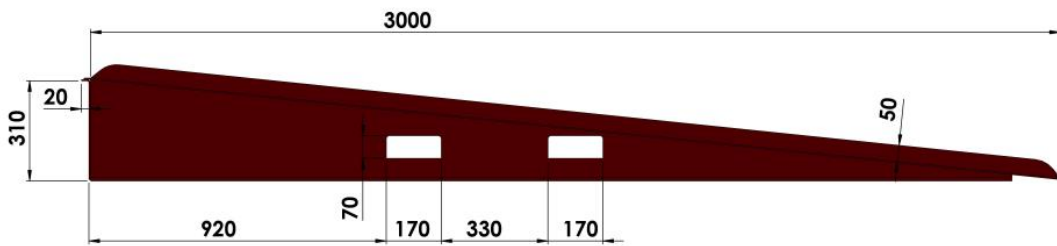

NAME - SURNAME	DATE	SIGN	QUANTITY	MASS (KG)	MATERIAL	PAGE/NT
DRAWN BY H. CANSEVER	10.12.2021		---			1/1
CONTROL A. HEPBILDI	10.12.2021					
APPROVAL S. ENTZMANN	10.12.2021					
SCALE 1:20						
PART/ASSEMBLY NAME			DRAWING DESCRIPTION		DRAWING NO.	
			#M83Y		---	



AZ MACHINERY - SLU, Matériels d'Élévation et Maintenance
 13 rue de la scierie - 66340 PALAISEAU DE CERDAGNE - France
 Téléphone : +33 (0) 37 46 3067 - contact@az-machinery.com - www.az-machinery.com
 Site : S24 654 958 000 19 - TVA : FR02 824 654 958 - N° EORI : FR02 824 654 958

7
1

12 11 10 9 8 7 6 5 4 3 2 1

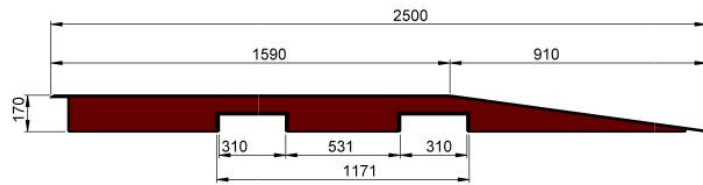

The entire surface is made of teardrop patterned sheet metal.

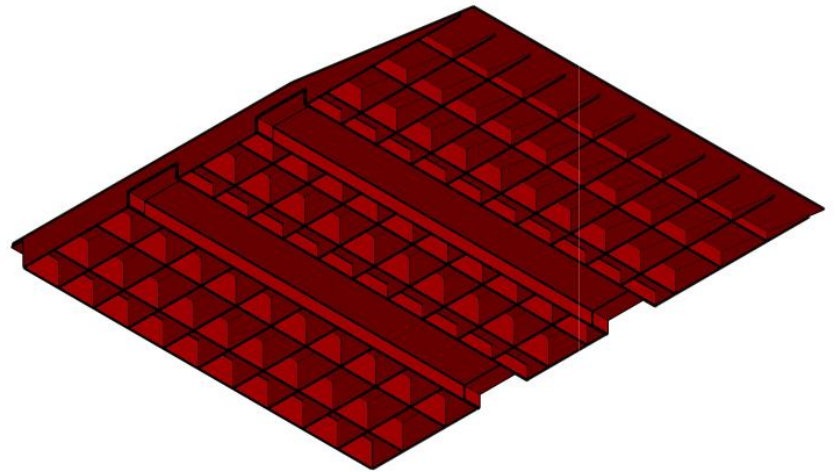
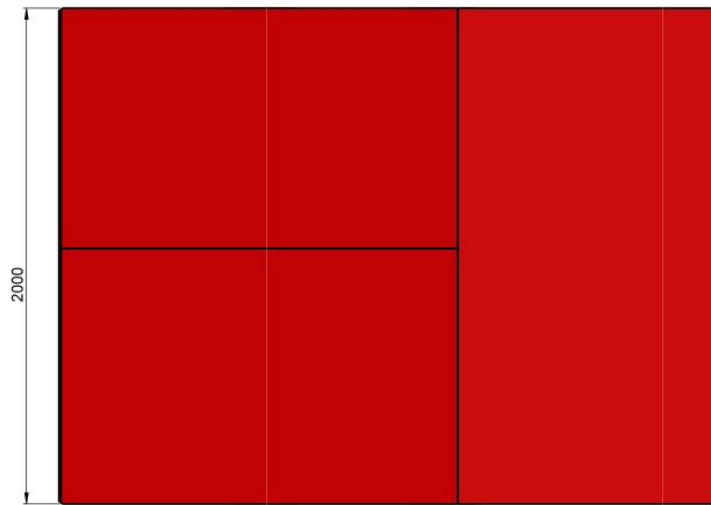
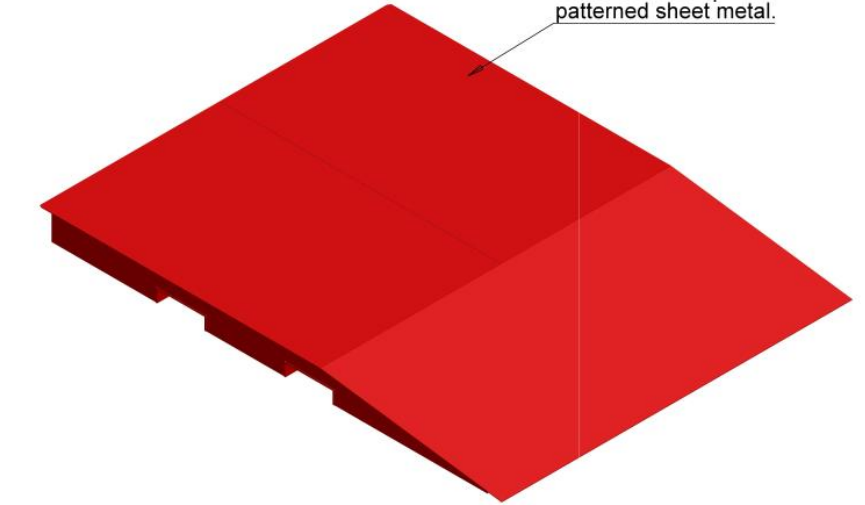

NAME - SURNAME	DATE	SIGN	QUANTITY	MASS (KG)	MATERIAL	PAGE/NT
DRAWN BY: B.QZ/FCI	31.03.2022		---			1/1
CONTROL: A.HEPBILDI	31.03.2022					
APPROVAL: J.GUQUET	31.03.2022					
SCALE: 1:20						
PART/ASSEMBLY NAME			DRAWING DESCRIPTION:		DRAWING NO.	
			#M83Y		---	



AZ MACHINERY - SLU, Matériels d'Élévation et Maintenance
 13 rue de la scierie - 05 340 PÉLASSI DE CÉRÉACRES - France
 Téléphone : +33 (0) 27 46 306 - contact@az-machinery.com - www.az-machinery.com
 Site : S24 654 958 000 19 - TVA : FR02 824 654 958 - N° EORI : FR02 824 654 958

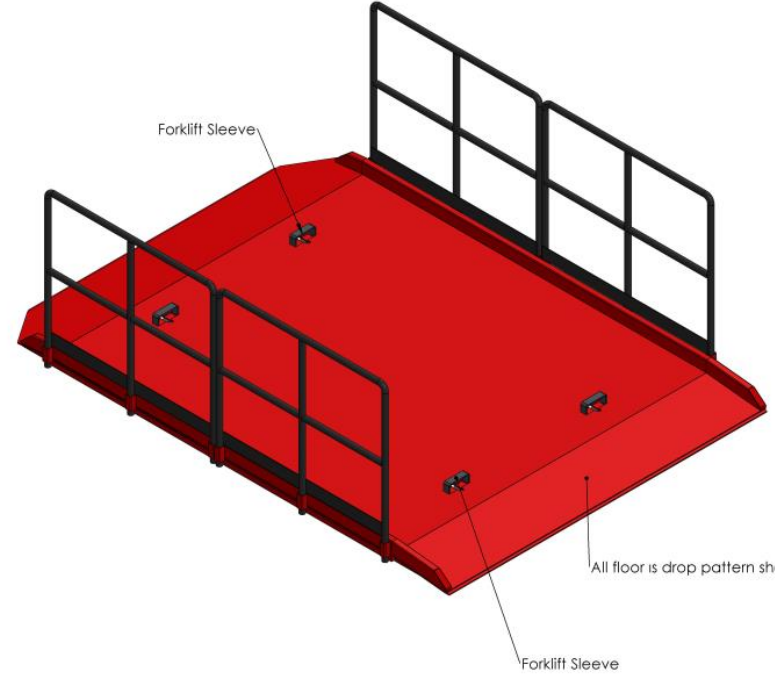
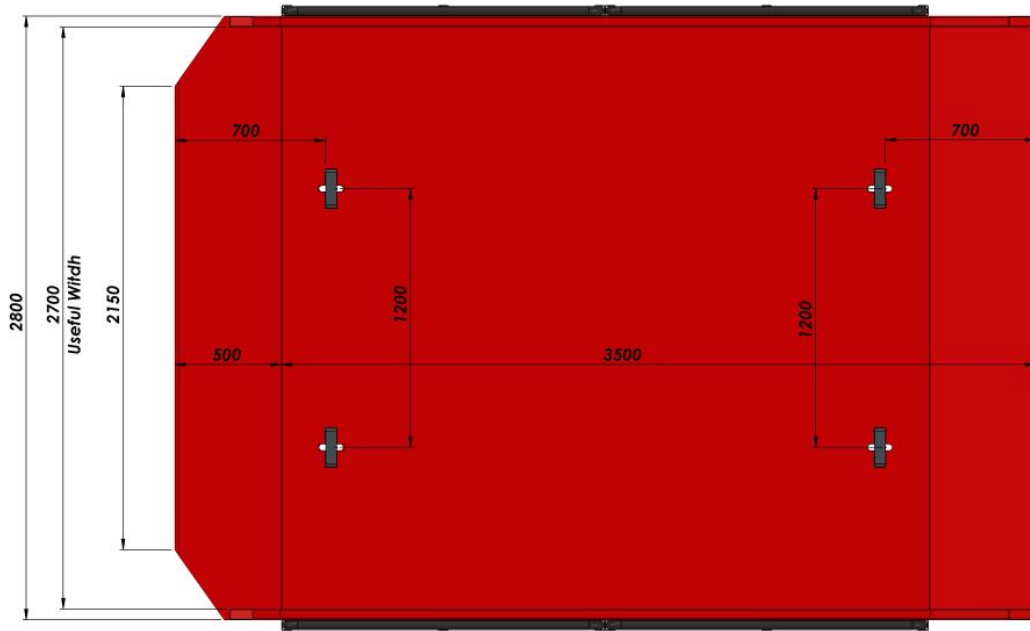
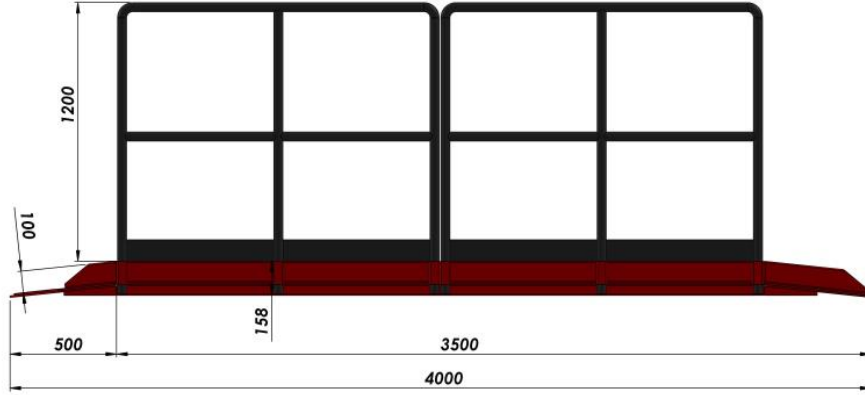

CAPACITY: 20000 KG

NAME - SURNAME	DATE	SIGN	QUANTITY	MASS (KG)	MATERIAL	PAGE NR
DRAWN BY: H. CANSEVER	18.05.2022		---			1/1
CONTROL: A. HEPBILDI	18.05.2022					
APPROVAL: S. ENTZMANN	18.05.2022					
SCALE: 1:20						
PART/ASSEMBLY NAME	DRAWING DESCRIPTION:		DRAWING NO.			
	#7N33		---			



AZ MACHINERY - SLU, Matériels d'Élévation et Maintenance
 13 rue de la scierie - 05 340 PALAISEAU DE CERDAGNY - France
 Téléphone : +33 37 27 46 100 - contact@az-machinery.com - www.az-machinery.com
 Site : 024 654 958 000 TVA - TVA : FR02 824 654 958 - N° EORI : FR02 824 654 958



DRAWINGS

Rampes mobiles
Rampes fixes
Plateformes logistiques
Réhausses
Tables de quai mobiles
Tables de quai fixes
Passerelles
Rampes pour conteneurs
Niveleurs
Autres confections

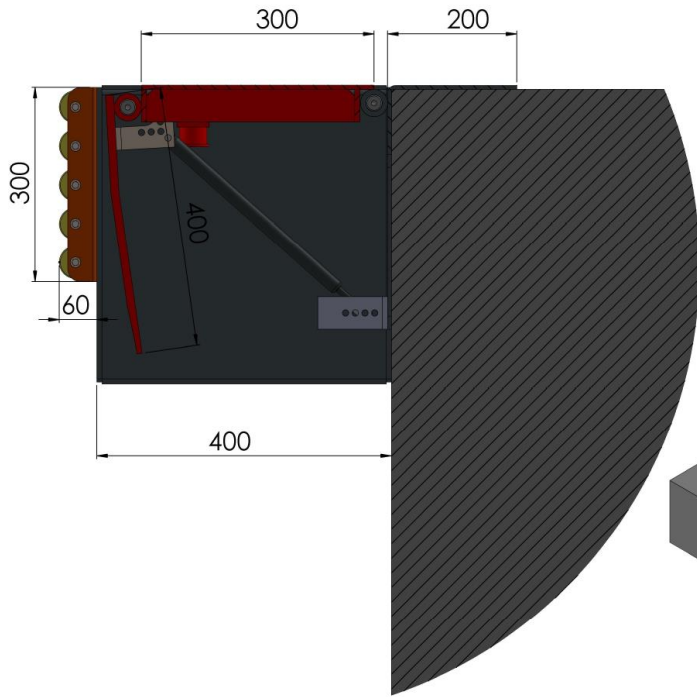
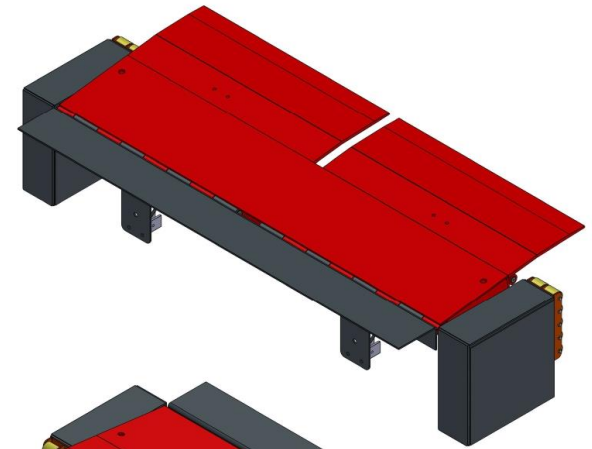
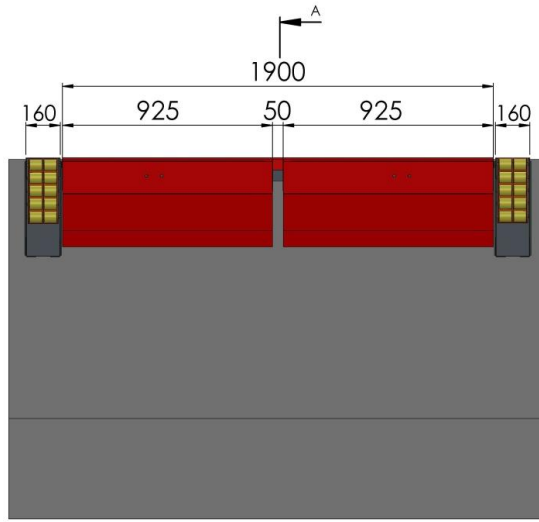
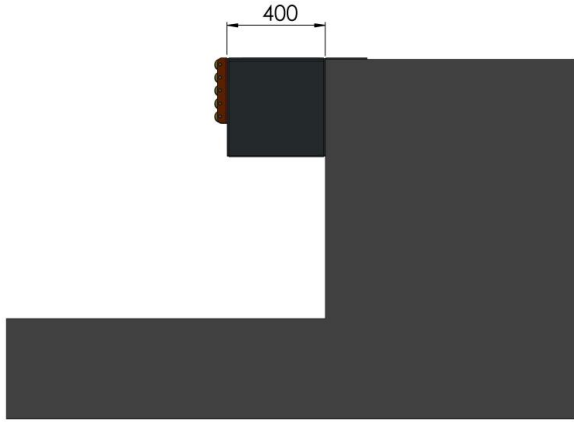

LIPSARE TWO PIECE

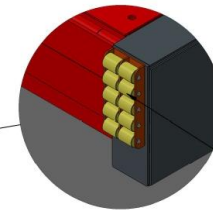
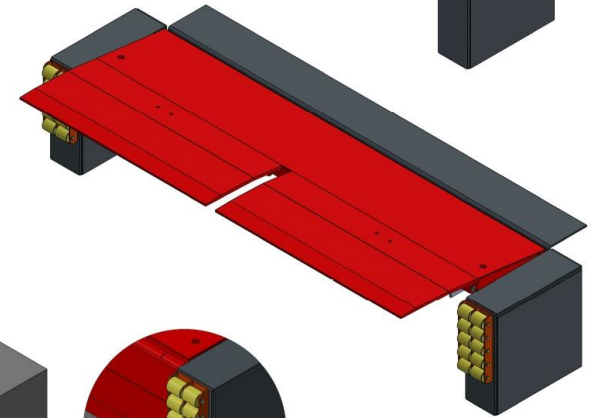
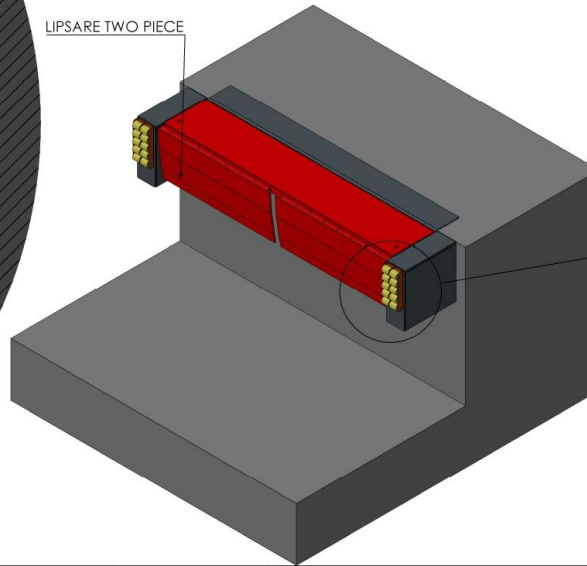

DETAIL B
SCALE 1 : 10

WHEELED BUMPER

NAME-SURNAME	DATE	SIGN	QUANTITY	MASS (KG)	MATERIAL	PAGE NR
DRAWN BY: H. CANSEVER	---	---	---	---	---	1/1
CONTROL: N. HATIPOGLU	---	---	---	---	---	---
APPROVAL: A. HEPBILDI	---	---	---	---	---	---
SCALE: 1:20	---	---	---	---	---	---
PARTASSEMBLY NAME			DRAWING DESCRIPTION		DRAWING NO	
			#MA8N		---	



AZ MACHINERY - SLU, Matériels d'Élévation et Manutention
 13 rue de la scierie - 06340 PALAISEAU DE CERDASNIEN - France
 Téléphone : +33 (0) 47 47 40 500 - contact@az-machinery.com - www.az-machinery.com
 Site : 024 654 958 000 10 - TVA : FR02 824 654 958 - N° EORI : FRAD 824 654 958

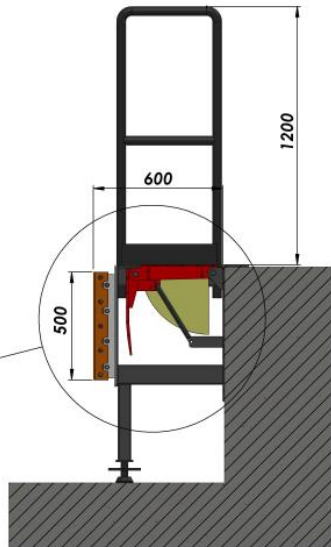
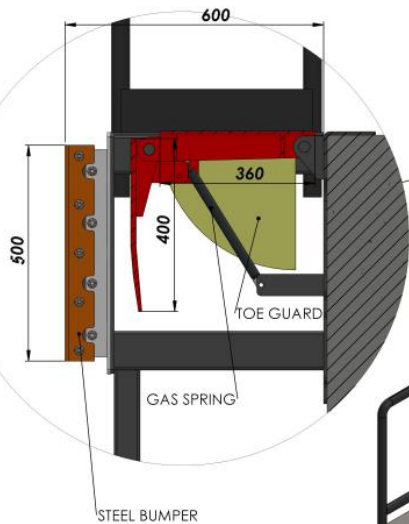

SECTION A-A
SCALE 1 : 15

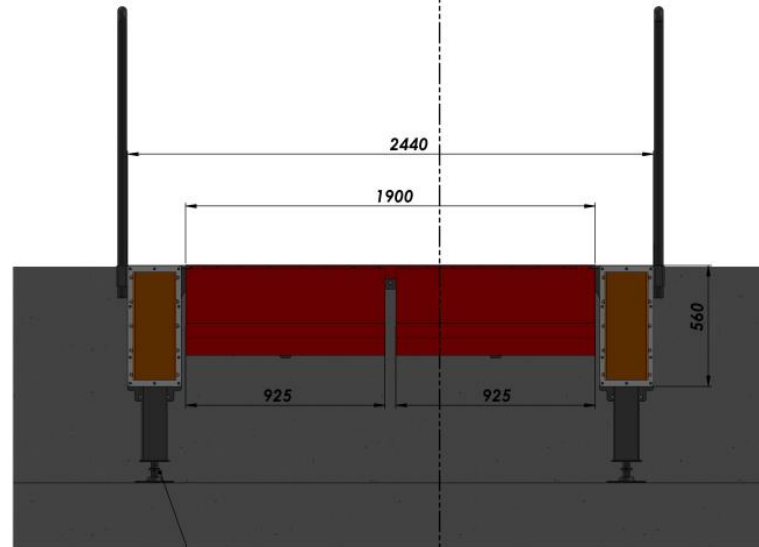

ADJUSTABLE LEG

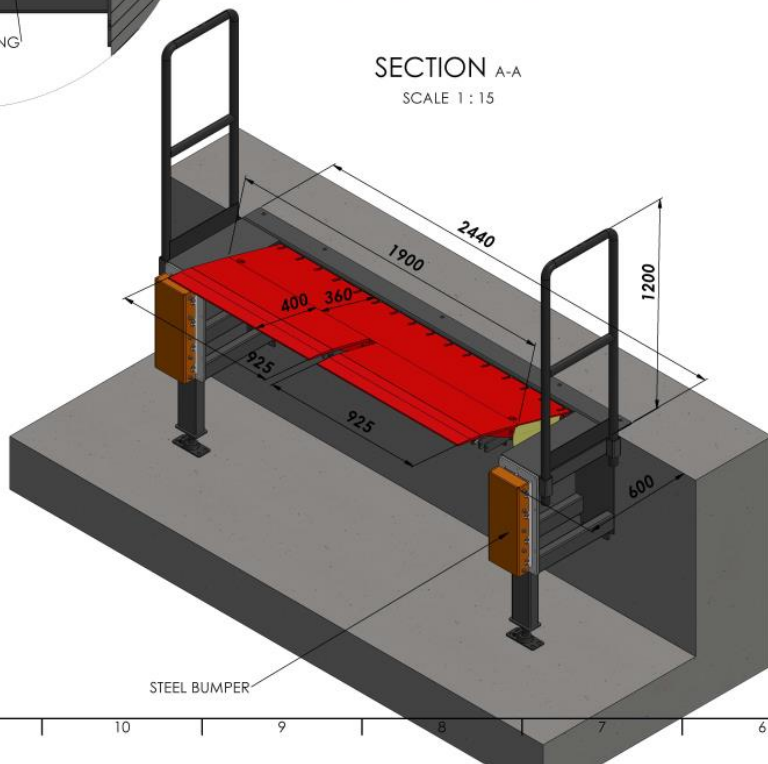

STEEL BUMPER

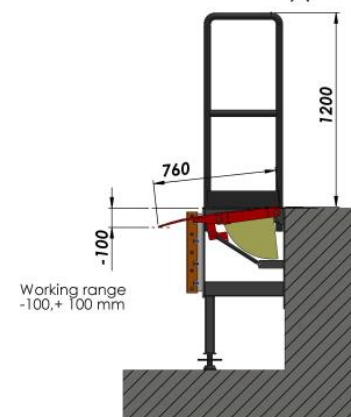

Working range
-100,+ 100 mm

NAME - SURNAME	DATE	SIGN	QUANTITY	MASS (KG)	MATERIAL	PAGE/NT
DRAWN BY: H. CANSEVER	19.04.2022		---			1/1
CONTROL: A. HEPBILDI	19.04.2022					
APPROVAL: S. ENTZMANN	19.04.2022					
SCALE: 1:20						
PART/ASSEMBLY NAME	DRAWING DESCRIPTION		DRAWING NO.			
	#6ZW2 Manual Mini leveler		---			



AZ MACHINERY - SLU, Matériels d'Élévation et Manutention
13 rue de la scierie - 36 340 PILLATI DE CIEBACQNE - France
Téléphone : +33 (0) 27 48 500 - contact@az-machinery.com - www.az-machinery.com
Site : 424 654 958 666 19 - TVA : FR02 824 654 958 - N° EORI : FR02 824 654 958

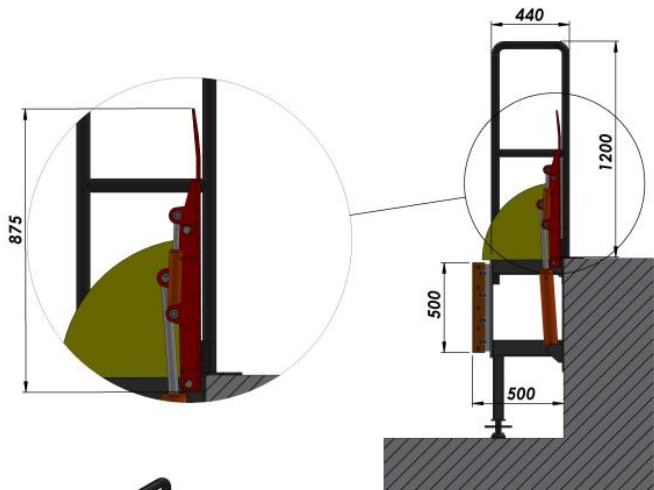

SECTION A-A
SCALE 1 : 18

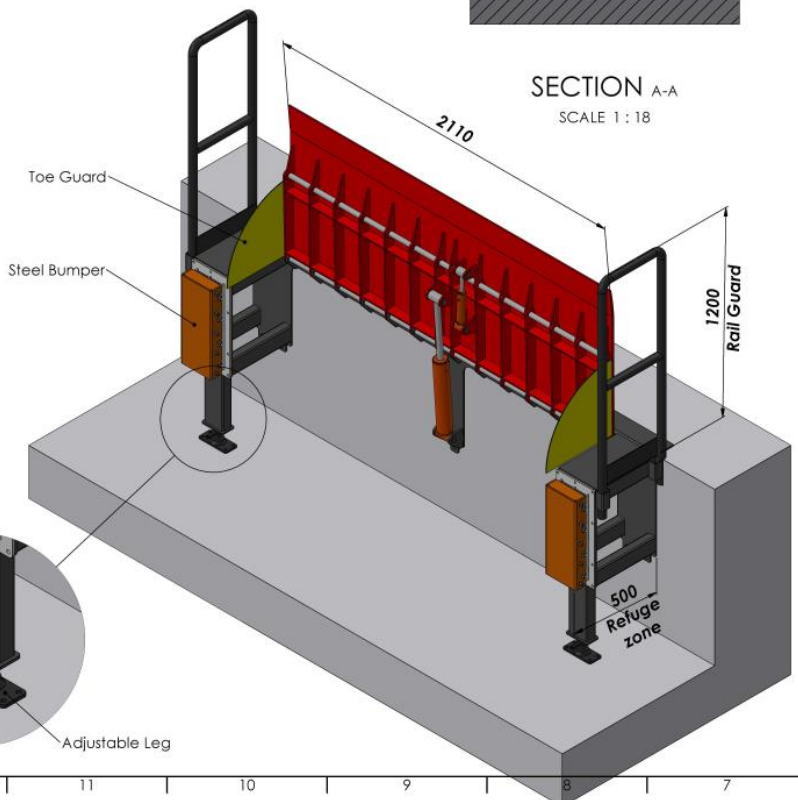
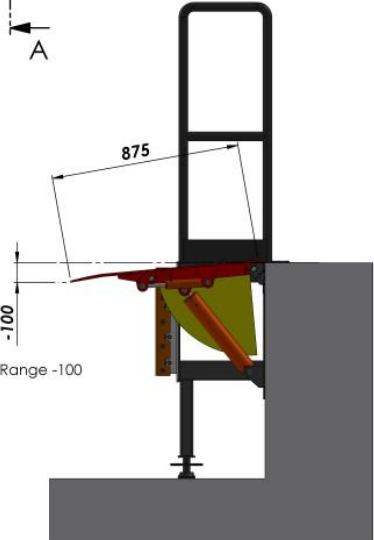
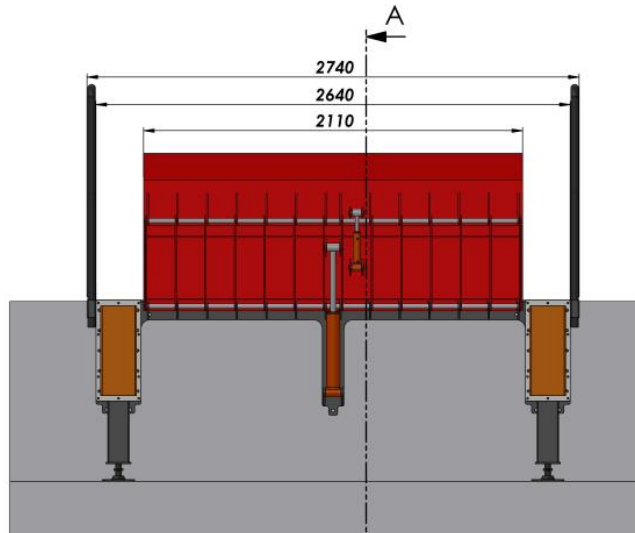

NAME - SURNAME	DATE	SIGN	QUANTITY	MASS (KG)	MATERIAL	PAGE NR
DRAWN BY H. CANSEVER	10.03.2022		---			1/1
CONTROL A. HEPBILDI	10.03.2022					
APPROVAL S. ENTZMANN	10.03.2022					
SCALE 1:50						
PART/ASSEMBLY NAME	DRAWING DESCRIPTION		DRAWING NO.			
	#E4EE		---			



AZ MACHINERY - SLU, Matériels d'Élévation et Maintenance
 13 rue de la scierie - 46340 PALATRI DE CHERBOURG - France
 Téléphone : +33 (0) 27 48 500 - contact@az-machinery.com - www.az-machinery.com
 Site : 424 654 958 (FR) TVA : FR02 824 654 958 - N° EORI : FR02 824 654 958

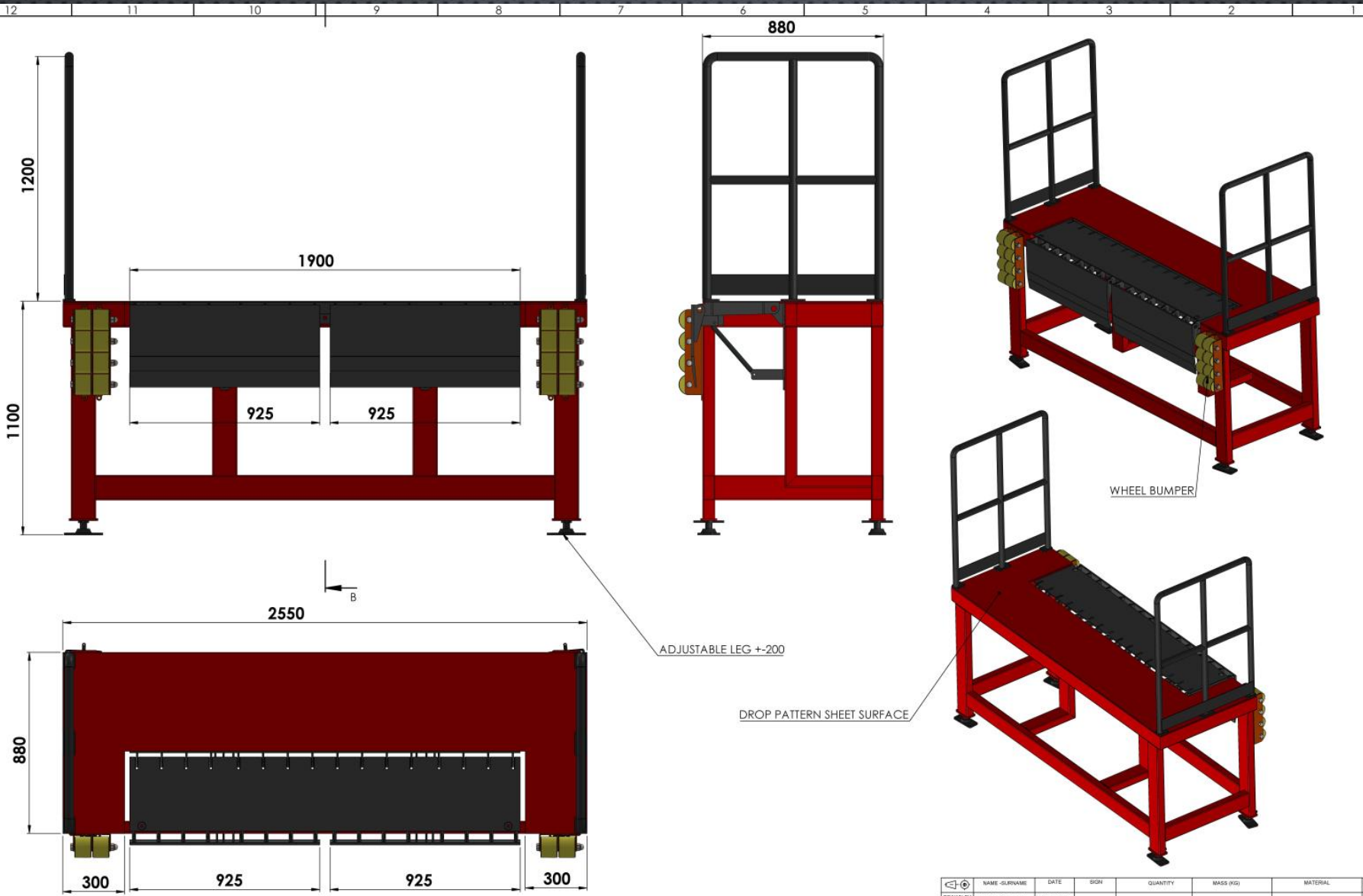

NAME - SURNAME	DATE	SIGN	QUANTITY	MASS (KG)	MATERIAL	PAGE NR
DRAWN BY H. CANSEVER	19.10.2021		---			1/1
CONTROL A. HEPBILDI	19.10.2021					
APPROVAL S. ENTZMANN	19.10.2021					
SCALE 1:20						
PART/ASSEMBLY NAME	DRAWING DESCRIPTION			DRAWING NO.		
	PLATFORM WITH MANUEL EDGE DOCK LEVELER			---		

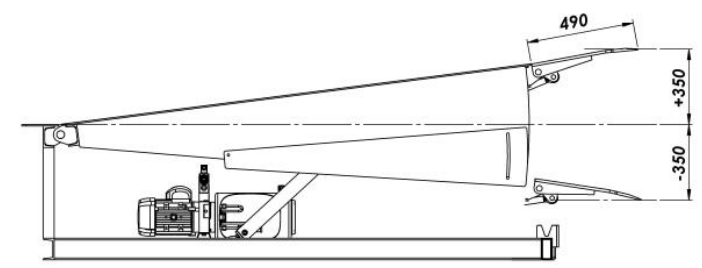
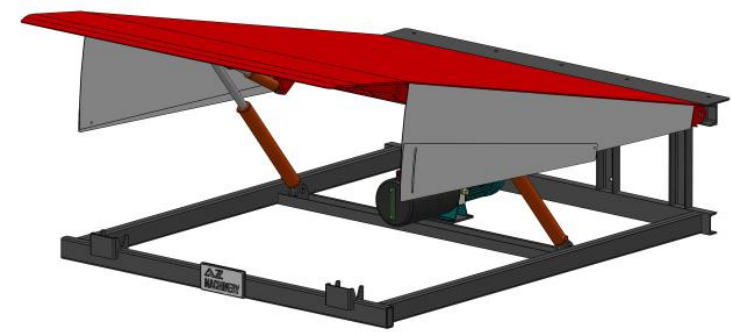
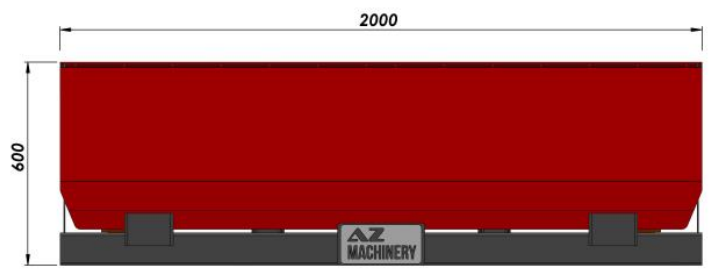
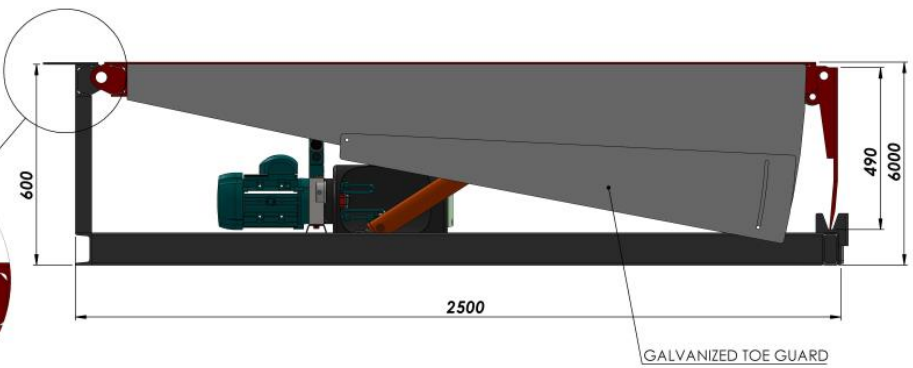

AZ MACHINERY - SLU, Matériels d'Élévation et Manutention
 13 rue de la scierie - 46 340 PALLATI DE CERBACHON - France
 Téléphone : 03 25 27 48 500 - contact@az-machinery.com - www.az-machinery.com
 Site : 424 654 958 660 FR - TVA : FR02 824 654 958 - N° ED081 - FR03 824 654 958



NAME (SURNAME)	DATE	SIGN	QUANTITY	MASS (KG)	MATERIAL	PAGE (NR)
DRAWN BY: H. CANSEVER	01.02.2022		---			1/1
CONTROL: A. HEPBILDI	01.02.2022					
APPROVAL: S. ENTZMANN	01.02.2022					
SCALE: 1:20						
PART/ASSEMBLY NAME	DRAWING DESCRIPTION:		DRAWING NO.			
	2000X2500_490 HINGED LIP DOCK LEVELER		---			

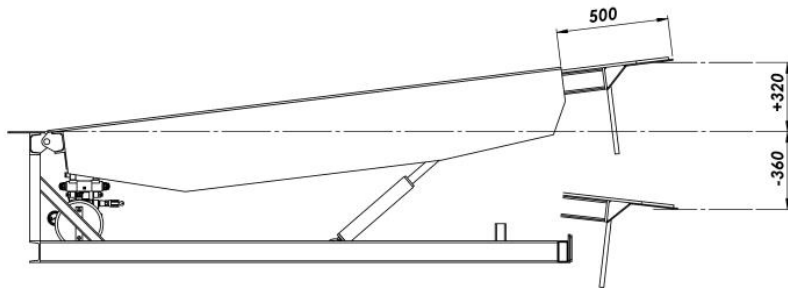
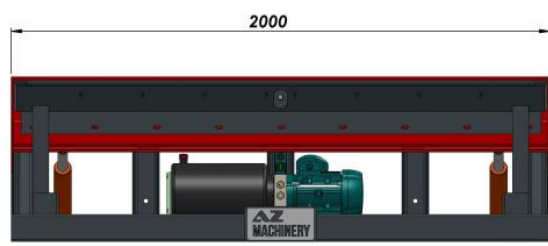
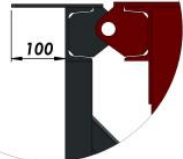
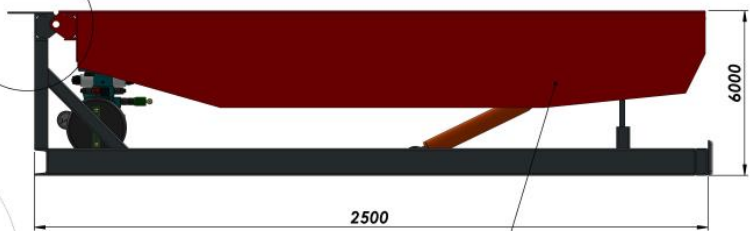

AZ MACHINERY - SLU, Matériels d'Élévation et Maintenance
 13 rue de la source - 66340 PALLATI DE CERDAGNAC - France
 Téléphone : +33 (0) 27 48 500 - contact@az-machinery.com - www.az-machinery.com
 Site : 624 654 958 666 19 - TVA : FR02 624 654 958 - N° EORI : FR02 624 654 958



NAME - SURNAME	DATE	SIGN	QUANTITY	MASS (KG)	MATERIAL	PAGE NR
DRAWN BY: H. CANSEVER	01.02.2022		---			1/1
CONTROL: A. HEPBILDI	01.02.2022					
APPROVAL: S. ENTZMANN	01.02.2022					
SCALE: 1:20						
PART/ASSEMBLY NAME			DRAWING DESCRIPTION		DRAWING NO.	
			2000x2500...500 TELESCOPIC DOCK LEVELER		---	



AZ MACHINERY - SLU, Matériels d'Élévation et Maintenance
 13 rue de la scierie - 86 340 PALAIS DE CERAMIQUE - France
 Téléphone : +33 (0) 27 48 500 - contact@az-machinery.com - www.az-machinery.com
 Site : AZ 654 958 666 FR - TVA : FR02 824 654 958 - N° EORI : FR02 824 654 958

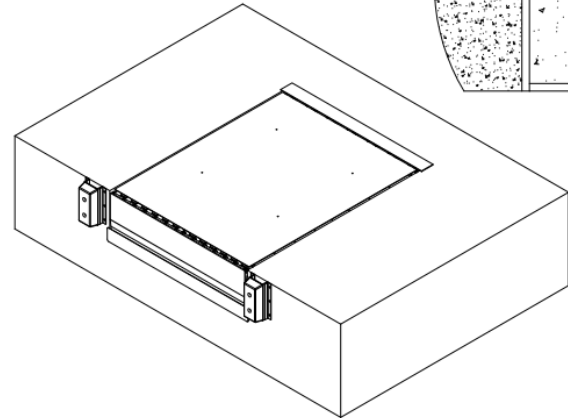
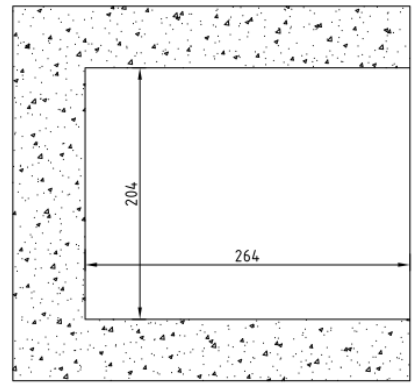
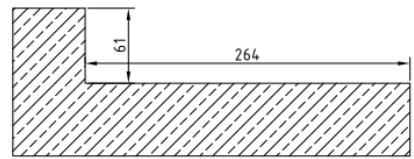
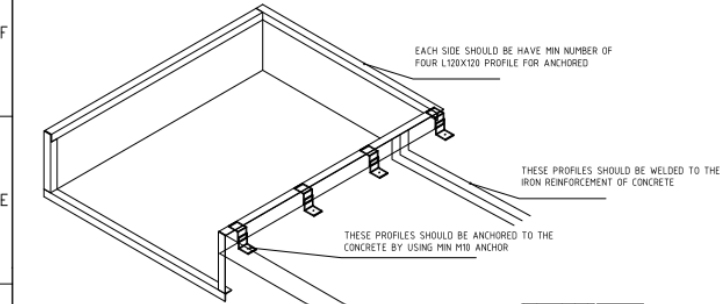
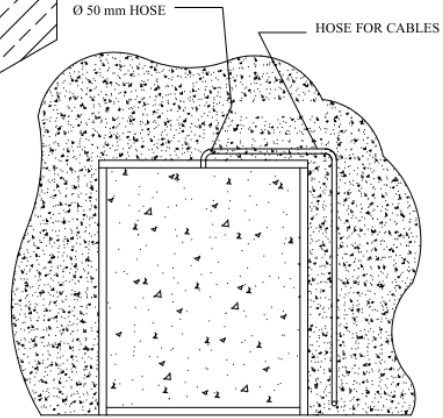
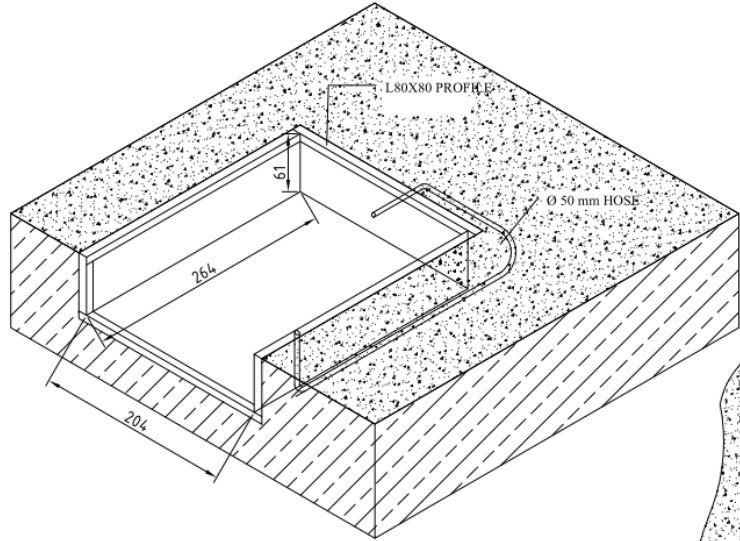
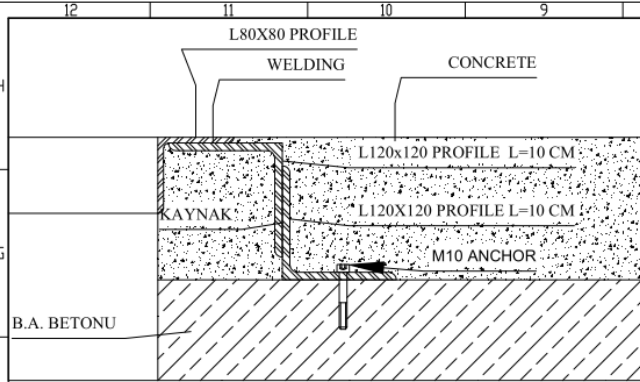

NOTE: ALL DIMENSIONS ARE IN CM

NAME - SURNAME	DATE	SIGN	QUANTITY	MASS (KG)	MATERIAL	page/nb
DRAWN BY H. CANSEVER	19.10.2021		---			1/1
CONTROL A. HEPBILDI	19.10.2021					
APPROVAL S. ENTZMANN	19.10.2021					
SCALE 1:20						
PARTSSEMBLY NAME		DRAWING DESCRIPTION			DRAWING NO	
		HINGED LIP DOCK LEVELER LAYOUT			---	



AZ MACHINERY - SLU, Matériels d'Élévation et Manutention
13 rue de la science - 68 340 PALAZZ DE CERDANNE - France
Téléphone : +33 33 27 41 369 contact@az-machinery.com www.az-machinery.com
Site: 824 654 108 001 FR - TVA : FR02 824 654 108 - N° EORI: FR02 824 654 108

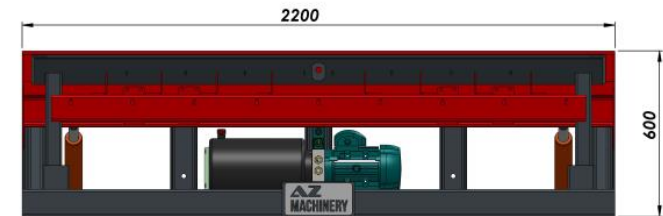
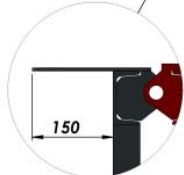
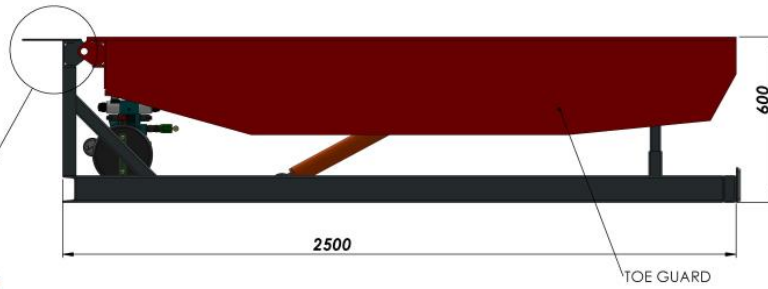

HOLES FOR ANCHORING

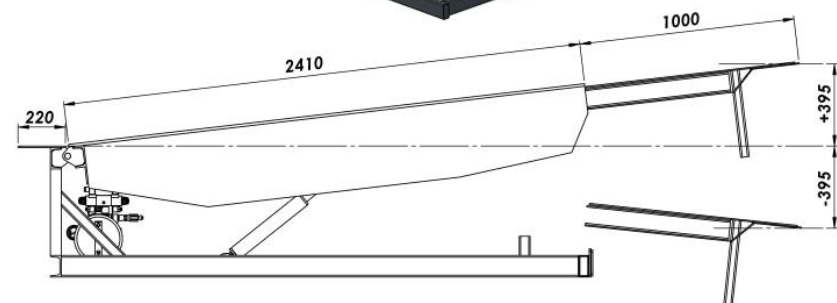

- TELESCOPIC LIP DOCK LEVELER FEATURES**
- 1- Working range: -395 / +395 mm and flap length: 1000 mm
 - 2- CE Certificate and compatible design with EN 1398 and ANSI MH30.2
 - 3- Platform floor made of teardrop pattern plates
 - 4- Flap is made of strengthened teardrop pattern plates
 - 5- Heavy load capacity hinge system for maximum resistance to moving load
 - 6- Side protection plates conforming to safety standards
 - 7- Maximum operating slope 12.5% (7°) for work and worker safety
 - 8- Platform floor is lifted with double hydraulic piston for high safety
 - 9- Hydraulic emergency declaration mechanism
 - 10- Electro-hydraulic system with IP65 protection class control panel
 - 11- Security lock for maintenance
 - 12- 450x200x100 mm dimensions and 70 Shore side bumpers

NAME (SURNAME)	DATE	SIGN	QUANTITY	MASS (KG)	MATERIAL	PAGE NO.
DRAWN BY: H. CANSEVER	10.06.2022		---			1/1
CONTROL: A. HEPBILDI	10.06.2022					
APPROVAL: S. ENTZMANN	10.06.2022					
SCALE: 1:20						
PART/ASSEMBLY NAME	DRAWING DESCRIPTION		DRAWING NO.			
	#K659		---			



AZ MACHINERY - SLU, Matériels d'Élévation et Maintenance
 13 rue de la scierie - 36340 PALLATI DE CERDASNIER - France
 Téléphone : +33 (0) 27 46 500 - contact@az-machinery.com - www.az-machinery.com
 Site : 424 654 958 666 19 - TVA : FR02 824 654 958 - 3° ED06 - FR03 824 654 958



DRAWINGS

Rampes mobiles
Rampes fixes
Plateformes logistiques
Réhausses
Tables de quai mobiles
Tables de quai fixes
Passerelles
Rampes pour conteneurs
Niveleurs
Autres confections

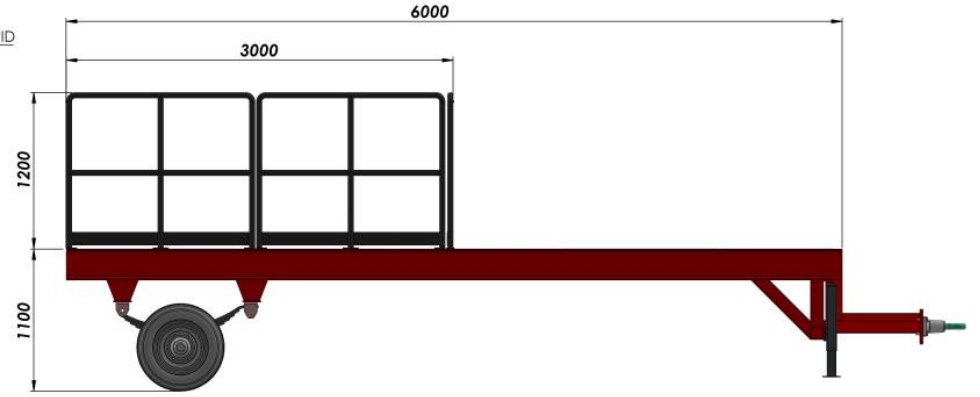
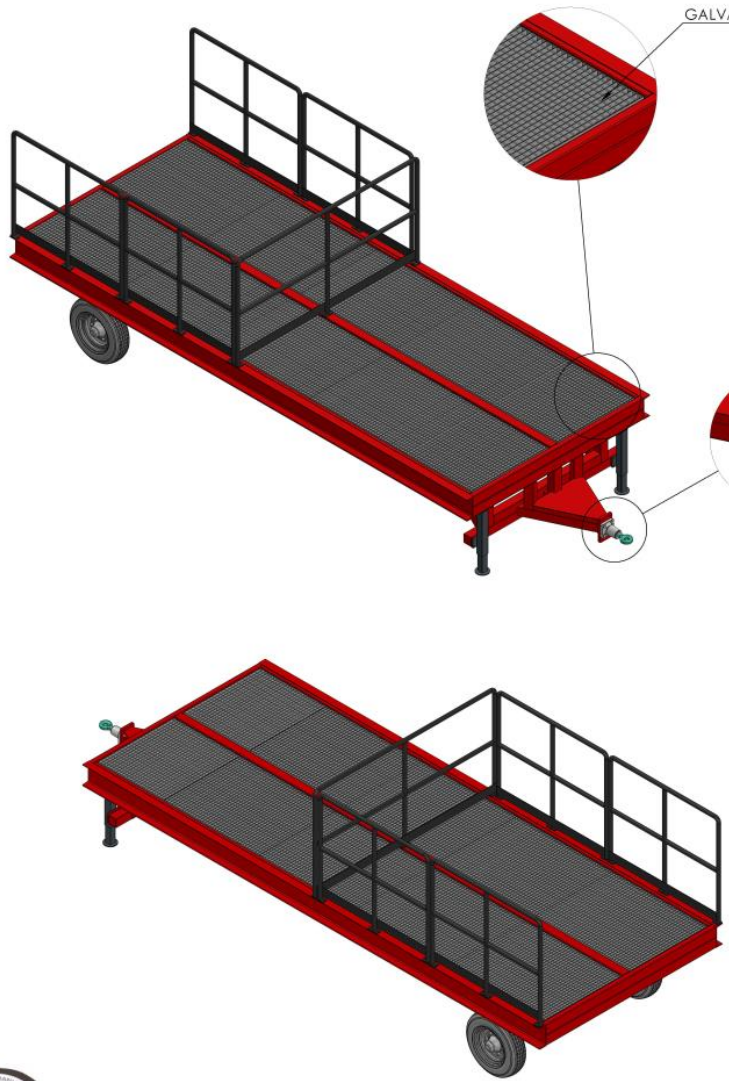

NAME - SURNAME	DATE	SIGN	QUANTITY	MASS (KG)	MATERIAL	PAGE NR
DRAWN BY: H. CANSEVER	09 01 2022		---			1/1
CONTROL: A. HEPBILDI	09 01 2022					
APPROVAL: S. ENTZMANN	09 01 2022					
SCALE: 1:50						
PART/ASSEMBLY NAME			DRAWING DESCRIPTION		DRAWING NO.	
			#TA83		---	



AZ MACHINERY - SLU, Matériels d'Élévation et Maintenance
 13 rue de la source - 46 540 PULVILLI DE CEEBACHS - France
 Téléphone : +33 (0) 17 48 100 - contact@az-machinery.com - www.az-machinery.com
 Site : 424 654 958 000 FR - TVA : FR02 824 654 958 - 3^e EORL - REA02 824 654 958

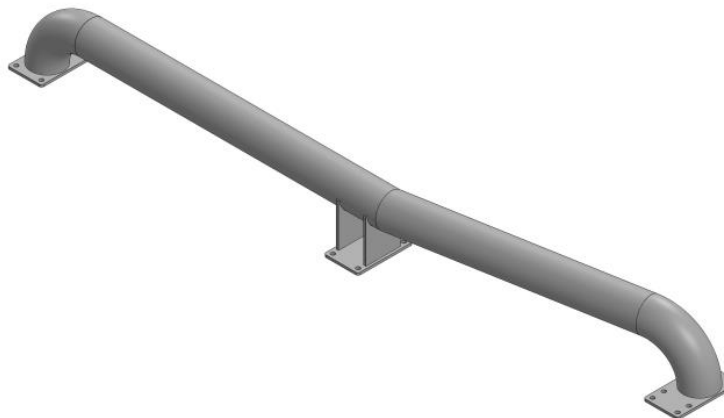
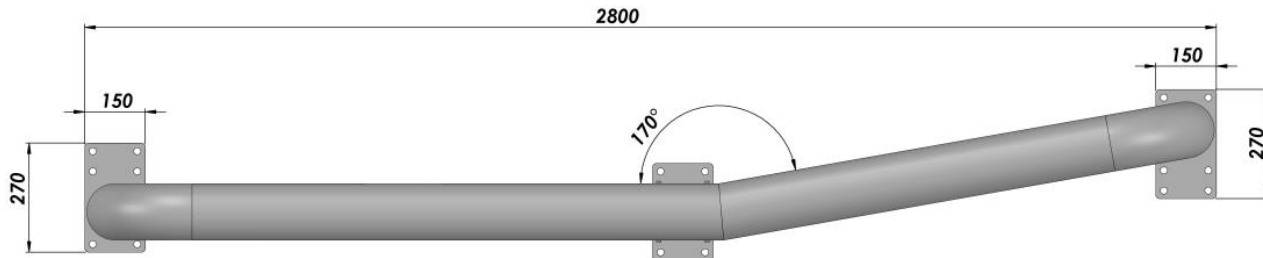
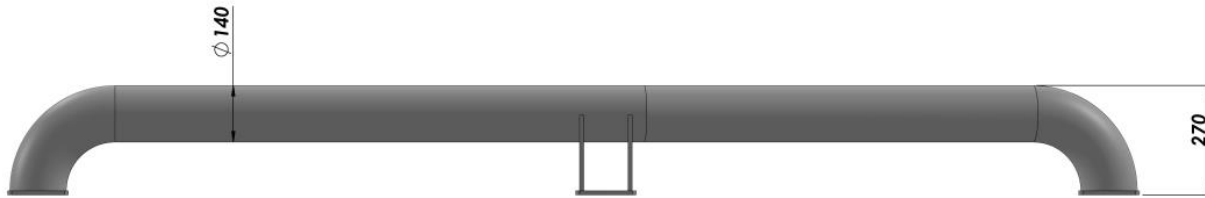

NAME - SURNAME	DATE	SIGN	QUANTITY	MASS (KG)	MATERIAL	PAGE/NT
DRAWN BY: H. CANSEVER	18.01.2022		---			1/1
CONTROL: A. HEPBILDI	18.01.2022					
APPROVAL: S. ENTZMANN	18.01.2022					
SCALE: 1:20						
PART/ASSEMBLY NAME			DRAWING DESCRIPTION		DRAWING NO.	



AZ MACHINERY - SLU, Matériels d'Élévation et Manutention
 13 rue de la mairie - 16 540 PALLAS DE CÉBERACONS - France
 Téléphone : +33 (0) 37 48 500 - contact@az-machinery.com - www.az-machinery.com
 Site : 824 654 958 000 FR - TVA : FR02 824 654 958 - N° EORI : FR02 824 654 958

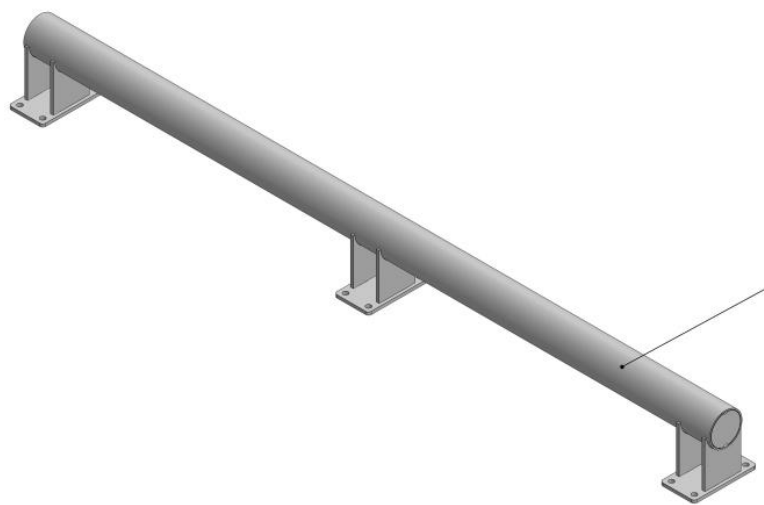
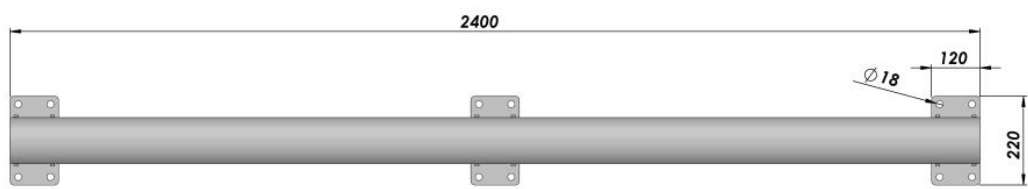
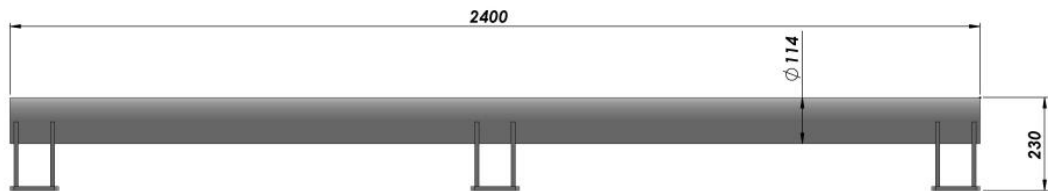

ALL SURFACES ARE HOT DEEP GALVANIZED

NAME - SURNAME	DATE	SIGN	QUANTITY	MASS (KG)	MATERIAL	PAGE/NT
DRAWN BY: H. CANSEVER	18.01.2022		---			1/1
CONTROL: A. HEPBILDI	18.01.2022					
APPROVAL: S. ENTZMANN	18.01.2022					
SCALE: 1:10						
PART/ASSEMBLY NAME			DRAWING DESCRIPTION		DRAWING NO.	



AZ MACHINERY - SLU, Matériels d'Élévation et Maintenance
 13 rue de la scierie - 16 540 PALLATI DE CEZEMANN - France
 Téléphone : +33 (0) 37 48 500 - contact@az-machinery.com - www.az-machinery.com
 Site : 824 654 958 000 FR - TVA : FR02 824 654 958 - 3° EORI : FR02 824 654 958

